

### FEATURES

**Ultralow noise:** 0.95 nV/ $\sqrt{\text{Hz}}$ , 2.6 pA/ $\sqrt{\text{Hz}}$

#### Ultralow distortion

2<sup>nd</sup> harmonic  $R_L = 1 \text{ k}\Omega$ ,  $G = +2$

-92 dB @ 10 MHz

3<sup>rd</sup> harmonic  $R_L = 1 \text{ k}\Omega$ ,  $G = +2$

-105 dB @ 10 MHz

#### High speed

**GBWP:** 3.8 GHz

-3 dB bandwidth:

700 MHz ( $G = +2$ )

550 MHz ( $G = +10$ )

#### Slew rate:

475 V/ $\mu\text{s}$  ( $G = +2$ )

1350 V/ $\mu\text{s}$  ( $G = +10$ )

#### New pinout

**Custom external compensation, gain range -1, +2 to +10**

**Supply current:** 15 mA

**Offset voltage:** 0.5 mV max

**Wide supply voltage range:** 5 V to 12 V

### GENERAL DESCRIPTION

The AD8099 is an ultralow noise (0.95 nV/ $\sqrt{\text{Hz}}$ ) and distortion (-92 dBc @10 MHz) voltage feedback op amp, the combination of which make it ideal for 16- and 18-bit systems. The AD8099 features a new, highly linear, low noise input stage that increases the full power bandwidth (FPBW) at low gains with high slew rates. ADI's proprietary next generation XFCB process enables such high performance amplifiers with relatively low power.

The AD8099 features external compensation, which lets the user set the gain bandwidth product. External compensation allows gains from +2 to +10 with minimal trade-off in bandwidth. The AD8099 also features an extremely high slew rate of 1350 V/ $\mu\text{s}$ , giving the designer flexibility to use the entire dynamic range without trading off bandwidth or distortion. The AD8099 settles to 0.1% in 18 ns and recovers from overdrive in 50 ns.

The AD8099 drives 100  $\Omega$  loads at breakthrough performance levels with only 15 mA of supply current. With the wide supply voltage range (5 V to 12 V), low offset voltage (0.1 mV typ), wide bandwidth (700 MHz for  $G = +2$ ), and a GBWP up to 3.8 GHz, the AD8099 is designed to work in a wide variety of applications.

#### Rev. B

Information furnished by Analog Devices is believed to be accurate and reliable. However, no responsibility is assumed by Analog Devices for its use, nor for any infringements of patents or other rights of third parties that may result from its use. Specifications subject to change without notice. No license is granted by implication or otherwise under any patent or patent rights of Analog Devices. Trademarks and registered trademarks are the property of their respective owners.

### APPLICATIONS

Pre-amplifiers

Receivers

Instrumentation

Filters

IF and baseband amplifiers

A-to-D drivers

DAC buffers

Optical electronics

### CONNECTION DIAGRAMS

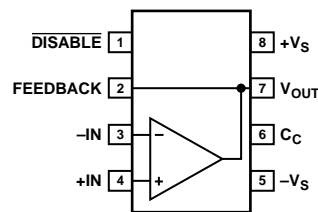

Figure 1. 8-Lead CSP (CP-8)

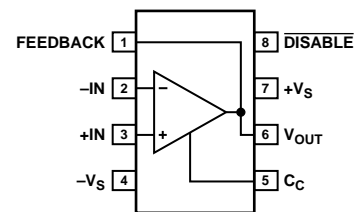

Figure 2. 8-Lead SOIC-ED (RD-8)

The AD8099 is available in a 3 mm  $\times$  3 mm lead frame chip scale package (LFCSP) with a new pinout that is specifically optimized for high performance, high speed amplifiers. The new LFCSP package and pinout enable the breakthrough performance that previously was not achievable with amplifiers. The AD8099 is rated to work over the extended industrial temperature range, -40°C to +125°C.

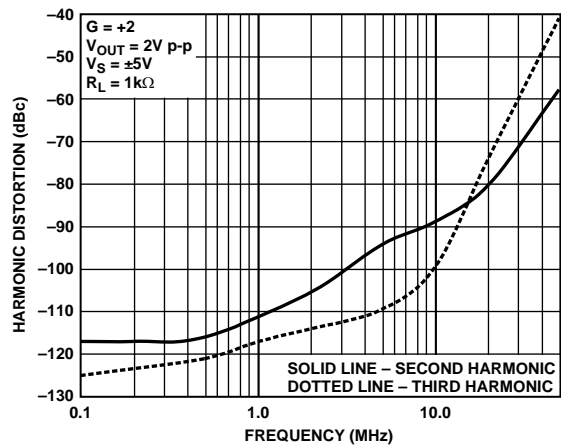

Figure 3. Harmonic Distortion vs. Frequency and Gain (SOIC)

## TABLE OF CONTENTS

Specifications.....	3	Recommended Values .....	17
Specifications with $\pm 5$ V Supply.....	3	Circuit Configurations .....	17
Specifications with +5 V Supply.....	4	Performance vs. Component values .....	19
Absolute Maximum Ratings.....	5	Total Output Noise Calculations and Design.....	20
Maximum Power Dissipation .....	5	Input Bias Current and DC Offset .....	21
ESD Caution.....	5	<a href="#">DISABLE</a> Pin and Input Bias Cancellation.....	21
Typical Performance Characteristics .....	6	16-Bit ADC Driver.....	22
Theory of Operation .....	15	Circuit Considerations .....	23
Applications.....	16	Design Tools and Technical Support.....	23
Using the AD8099 .....	16	Outline Dimensions .....	25
Circuit Components.....	16	Ordering Guide.....	26

## REVISION HISTORY

### 6/04—Data Sheet changed from REV. A to REV. B

Change to General Description .....	1
Changes to Maximum Power Dissipation section .....	5
Changes to Applications section .....	16
Changes to Table 7.....	24
Changes to Ordering Guide .....	26

### 1/04—Data Sheet changed from REV. 0 to REV. A

Inserted new Figure 3.....	1
Changes to Specifications.....	3
Inserted new Figures 22 to 34 .....	8
Inserted new Figures 51 to 55 .....	14
Changes to Theory of Operation section .....	16
Changes to Circuit Components section.....	17
Changes to Table 4.....	18
Changes to Figure 60.....	18
Changes to Total Output Noise Calculations and Design section.....	21
Changes to Figure 60.....	22
Changes to Figure 62.....	23
Changes to 16-Bit ADC Driver section .....	23
Changes to Table 6.....	23
Additions to PCB Layout section .....	23

### 11/03—Revision 0: Initial Version

## SPECIFICATIONS

### SPECIFICATIONS WITH $\pm 5$ V SUPPLY

$T_A = 25^\circ\text{C}$ ,  $G = +2$ ,  $R_L = 1\text{ k}\Omega$  to ground, unless otherwise noted. Refer to Figure 60 through Figure 66 for component values and gain configurations.

Table 1.

Parameter	Conditions	Min	Typ	Max	Unit
<b>DYNAMIC PERFORMANCE</b>					
-3 dB Bandwidth	$G = +5$ , $V_{OUT} = 0.2\text{ V p-p}$	450	510		MHz
	$G = +5$ , $V_{OUT} = 2\text{ V p-p}$	205	235		MHz
Bandwidth for 0.1 dB Flatness (SOIC/CSP)	$G = +2$ , $V_{OUT} = 0.2\text{ V p-p}$		34/25		MHz
Slew Rate	$G = +10$ , $V_{OUT} = 6\text{ V Step}$	1120	1350		V/ $\mu\text{s}$
	$G = +2$ , $V_{OUT} = 2\text{ V Step}$	435	470		V/ $\mu\text{s}$
Settling Time to 0.1%	$G = +2$ , $V_{OUT} = 2\text{ V Step}$		18		ns
<b>NOISE/DISTORTION PERFORMANCE</b>					
Harmonic Distortion (dBc) HD2/HD3	$f_c = 500\text{ kHz}$ , $V_{OUT} = 2\text{ V p-p}$ , $G = +10$		-102/-111		dBc
	$f_c = 10\text{ MHz}$ , $V_{OUT} = 2\text{ V p-p}$ , $G = +10$		-84/-92		dBc
Input Voltage Noise	$f = 100\text{ kHz}$		0.95		nV/ $\sqrt{\text{Hz}}$
Input Current Noise	$f = 100\text{ kHz}$ , $\overline{\text{DISABLE}}$ pin floating		2.6		pA/ $\sqrt{\text{Hz}}$
	$f = 100\text{ kHz}$ , $\overline{\text{DISABLE}}$ pin = $+V_S$		5.2		pA/ $\sqrt{\text{Hz}}$
<b>DC PERFORMANCE</b>					
Input Offset Voltage			0.1	0.5	mV
Input Offset Voltage Drift			2.3		$\mu\text{V}/^\circ\text{C}$
Input Bias Current	$\overline{\text{DISABLE}}$ pin floating		-6	-13	$\mu\text{A}$
	$\overline{\text{DISABLE}}$ pin = $+V_S$		-0.1	-2	$\mu\text{A}$
Input Bias Current Drift			3		nA/ $^\circ\text{C}$
Input Bias Offset Current			0.06	1	$\mu\text{A}$
Open-Loop Gain		82	85		dB
<b>INPUT CHARACTERISTICS</b>					
Input Resistance	Differential mode		4		k $\Omega$
	Common mode		10		M $\Omega$
Input Capacitance			2		pF
Input Common-Mode Voltage Range			-3.7 to +3.7		V
Common-Mode Rejection Ratio	$V_{CM} = \pm 2.5\text{ V}$	98	105		dB
<b>DISABLE PIN</b>					
$\overline{\text{DISABLE}}$ Input Voltage	Output disabled		<2.4		V
Turn-Off Time	50% of $\overline{\text{DISABLE}}$ to < 10% of final $V_{OUT}$ , $V_{IN} = 0.5\text{ V}$ , $G = +2$		105		ns
Turn-On Time	50% of $\overline{\text{DISABLE}}$ to < 10% of final $V_{OUT}$ , $V_{IN} = 0.5\text{ V}$ , $G = +2$		39		ns
Enable Pin Leakage Current	$\overline{\text{DISABLE}} = +5\text{ V}$		17	21	$\mu\text{A}$
$\overline{\text{DISABLE}}$ Pin Leakage Current	$\overline{\text{DISABLE}} = -5\text{ V}$		35	44	$\mu\text{A}$
<b>OUTPUT CHARACTERISTICS</b>					
Output Overdrive Recovery Time (Rise/Fall)	$V_{IN} = -2.5\text{ V to } 2.5\text{ V}$ , $G = +2$		30/50		ns
Output Voltage Swing	$R_L = 100\ \Omega$	-3.4 to +3.5	-3.6 to +3.7		V
	$R_L = 1\text{ k}\Omega$	-3.7 to +3.7	-3.8 to +3.8		V
Short-Circuit Current	Sinking and sourcing		131/178		mA
Off Isolation	$f = 1\text{ MHz}$ , $\overline{\text{DISABLE}} = \text{low}$		-61		dB
<b>POWER SUPPLY</b>					
Operating Range			$\pm 5$	$\pm 6$	V
Quiescent Current			15	16	mA
Quiescent Current (Disabled)	$\overline{\text{DISABLE}} = \text{Low}$		1.7	2	mA
Positive Power Supply Rejection Ratio	$+V_S = 4\text{ V to } 6\text{ V}$ , $-V_S = -5\text{ V}$ (input referred)	85	91		dB
Negative Power Supply Rejection Ratio	$+V_S = 5\text{ V}$ , $-V_S = -6\text{ V to } -4\text{ V}$ (input referred)	86	94		dB

# AD8099

## SPECIFICATIONS WITH +5 V SUPPLY

$V_S = 5\text{ V}$  @  $T_A = 25^\circ\text{C}$ ,  $G = +2$ ,  $R_L = 1\text{ k}\Omega$  to midsupply, unless otherwise noted. Refer to Figure 60 through Figure 66 for component values and gain configurations .

Table 2.

Parameter	Conditions	Min	Typ	Max	Unit
<b>DYNAMIC PERFORMANCE</b>					
-3 dB Bandwidth	$G = +5$ , $V_{OUT} = 0.2\text{ V p-p}$	415	440		MHz
	$G = +5$ , $V_{OUT} = 2\text{ V p-p}$	165	210		MHz
Bandwidth for 0.1 dB Flatness (SOIC/CSP)	$G = +2$ , $V_{OUT} = 0.2\text{ V p-p}$		33/23		MHz
Slew Rate	$G = +10$ , $V_{OUT} = 2\text{ V Step}$	630	715		V/ $\mu\text{s}$
	$G = +2$ , $V_{OUT} = 2\text{ V Step}$	340	365		V/ $\mu\text{s}$
Settling Time to 0.1%	$G = +2$ , $V_{OUT} = 2\text{ V Step}$		18		ns
<b>NOISE/DISTORTION PERFORMANCE</b>					
Harmonic Distortion (dBc) HD2/HD3	$f_c = 500\text{ kHz}$ , $V_{OUT} = 1\text{ V p-p}$ , $G = +10$ $f_c = 10\text{ MHz}$ , $V_{OUT} = 1\text{ V p-p}$ , $G = +10$		-82/-94		dBc
			-80/-75		dBc
Input Voltage Noise	$f = 100\text{ kHz}$		0.95		nV/ $\sqrt{\text{Hz}}$
Input Current Noise	$f = 100\text{ kHz}$ , $\overline{\text{DISABLE}}$ pin floating		2.6		pA/ $\sqrt{\text{Hz}}$
	$f = 100\text{ kHz}$ , $\overline{\text{DISABLE}}$ pin = $+V_S$		5.2		pA/ $\sqrt{\text{Hz}}$
<b>DC PERFORMANCE</b>					
Input Offset Voltage			0.1	0.5	mV
Input Offset Voltage Drift			2.5		$\mu\text{V}/^\circ\text{C}$
Input Bias Current	$\overline{\text{DISABLE}}$ pin floating		-6.2	-13	$\mu\text{A}$
	$\overline{\text{DISABLE}}$ pin = $+V_S$		-0.2	-2	$\mu\text{A}$
Input Bias Offset Current			0.05	1	$\mu\text{A}$
Input Bias Offset Current Drift			2.4		nA/ $^\circ\text{C}$
Open-Loop Gain	$V_{OUT} = 1\text{ V to }4\text{ V}$	76	81		dB
<b>INPUT CHARACTERISTICS</b>					
Input Resistance	Differential mode		4		k $\Omega$
	Common mode		10		M $\Omega$
Input Capacitance			2		pF
Input Common-Mode Voltage Range			1.3 to 3.7		V
Common-Mode Rejection Ratio	$V_{CM} = 2\text{ V to }3\text{ V}$	88	105		dB
<b>DISABLE PIN</b>					
$\overline{\text{DISABLE}}$ Input Voltage	Output disabled		<2.4		V
Turn-Off Time	50% of $\overline{\text{DISABLE}}$ to <10% of Final $V_{OUT}$ , $V_{IN} = 0.5\text{ V}$ , $G = +2$		105		ns
Turn-On Time	50% of $\overline{\text{DISABLE}}$ to <10% of Final $V_{OUT}$ , $V_{IN} = 0.5\text{ V}$ , $G = +2$		61		ns
Enable Pin Leakage Current	$\overline{\text{DISABLE}} = 5\text{ V}$		16	21	$\mu\text{A}$
$\overline{\text{DISABLE}}$ Pin Leakage Current	$\overline{\text{DISABLE}} = 0\text{ V}$		33	44	$\mu\text{A}$
<b>OUTPUT CHARACTERISTICS</b>					
Overdrive Recovery Time (Rise/Fall)	$V_{IN} = 0\text{ to }2.5\text{ V}$ , $G = +2$		50/70		ns
Output Voltage Swing	$R_L = 100\ \Omega$	1.5 to 3.5	1.2 to 3.8		V
	$R_L = 1\text{ k}\Omega$	1.2 to 3.8	1.2 to 3.8		V
Short-Circuit Current	Sinking and Sourcing		60/80		mA
Off Isolation	$f = 1\text{ MHz}$ , $\overline{\text{DISABLE}} = \text{Low}$		-61		dB
<b>POWER SUPPLY</b>					
Operating Range			$\pm 5$	$\pm 6$	V
Quiescent Current			14.5	15.4	mA
Quiescent Current (Disabled)	$\overline{\text{DISABLE}} = \text{Low}$		1.4	1.7	mA
Positive Power Supply Rejection Ratio	$+V_S = 4.5\text{ V to }5.5\text{ V}$ , $-V_S = 0\text{ V}$ (input referred)	84	89		dB
Negative Power Supply Rejection Ratio	$+V_S = 5\text{ V}$ , $-V_S = -0.5\text{ V to }+0.5\text{ V}$ (input referred)	84	90		dB

## ABSOLUTE MAXIMUM RATINGS

Table 3.

Parameter	Rating
Supply Voltage	12.6 V
Power Dissipation	See Figure 4
Differential Input Voltage	±1.8 V
Differential Input Current	±10 mA
Storage Temperature	–65°C to +125°C
Operating Temperature Range	–40°C to +125°C
Lead Temperature Range (Soldering 10 sec)	300°C
Junction Temperature	150°C

Stresses above those listed under Absolute Maximum Ratings may cause permanent damage to the device. This is a stress rating only; functional operation of the device at these or any other conditions above those indicated in the operational section of this specification is not implied. Exposure to absolute maximum rating conditions for extended periods may affect device reliability.

### MAXIMUM POWER DISSIPATION

The maximum safe power dissipation in the AD8099 package is limited by the associated rise in junction temperature ( $T_J$ ) on the die. The plastic encapsulating the die will locally reach the junction temperature. At approximately 150°C, which is the glass transition temperature, the plastic will change its properties. Even temporarily exceeding this temperature limit may change the stresses that the package exerts on the die, permanently shifting the parametric performance of the AD8099. Exceeding a junction temperature of 150°C for an extended period can result in changes in silicon devices, potentially causing failure.

The still-air thermal properties of the package and PCB ( $\theta_{JA}$ ), the ambient temperature ( $T_A$ ), and the total power dissipated in the package ( $P_D$ ) determine the junction temperature of the die. The junction temperature can be calculated as

$$T_J = T_A + (P_D \times \theta_{JA})$$

The power dissipated in the package ( $P_D$ ) is the sum of the quiescent power dissipation and the power dissipated in the package due to the load drive for all outputs. The quiescent power is the voltage between the supply pins ( $V_S$ ) times the quiescent current ( $I_S$ ). Assuming the load ( $R_L$ ) is referenced to midsupply, the total drive power is  $V_S/2 \times I_{OUT}$ , some of which is dissipated in the package and some in the load ( $V_{OUT} \times I_{OUT}$ ).

### ESD CAUTION

ESD (electrostatic discharge) sensitive device. Electrostatic charges as high as 4000 V readily accumulate on the human body and test equipment and can discharge without detection. Although this product features proprietary ESD protection circuitry, permanent damage may occur on devices subjected to high energy electrostatic discharges. Therefore, proper ESD precautions are recommended to avoid performance degradation or loss of functionality.

The difference between the total drive power and the load power is the drive power dissipated in the package.

$$P_D = \text{Quiescent Power} + (\text{Total Drive Power} - \text{Load Power})$$

$$P_D = (V_S \times I_S) + \left( \frac{V_S}{2} \times \frac{V_{OUT}}{R_L} \right) - \frac{V_{OUT}^2}{R_L}$$

RMS output voltages should be considered. If  $R_L$  is referenced to  $V_S$ , as in single-supply operation, then the total drive power is  $V_S \times I_{OUT}$ . If the rms signal levels are indeterminate, consider the worst case, when  $V_{OUT} = V_S/4$  for  $R_L$  to midsupply:

$$P_D = (V_S \times I_S) + \frac{(V_S/4)^2}{R_L}$$

In single-supply operation with  $R_L$  referenced to  $V_S$ , worst case is  $V_{OUT} = V_S/2$ .

Airflow will increase heat dissipation, effectively reducing  $\theta_{JA}$ . Also, more metal directly in contact with the package leads from metal traces, through holes, ground, and power planes will reduce the  $\theta_{JA}$ . Soldering the exposed paddle to the ground plane significantly reduces the overall thermal resistance of the package. Care must be taken to minimize parasitic capacitances at the input leads of high speed op amps, as discussed in the PCB Layout section.

Figure 4 shows the maximum safe power dissipation in the package versus the ambient temperature for the exposed paddle (e-pad) SOIC-8 (70°C/W), and CSP (70°C/W), packages on a JEDEC standard 4-layer board.  $\theta_{JA}$  values are approximations.

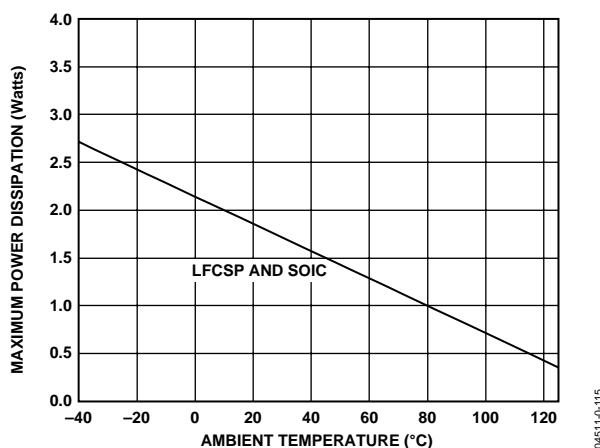
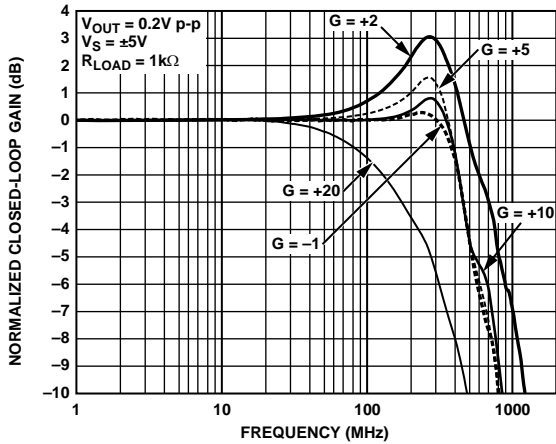

Figure 4. Maximum Power Dissipation



# TYPICAL PERFORMANCE CHARACTERISTICS

Default Conditions:  $V_S = \pm 5\text{ V}$ ,  $T_A = 25^\circ\text{C}$ ,  $R_L = 1\text{ k}\Omega$  tied to ground unless otherwise noted. Refer to Figure 63 through Figure 66 for component values and gain configurations.



04511-0-074

Figure 5. Small Signal Frequency Response for Various Gains (SOIC)

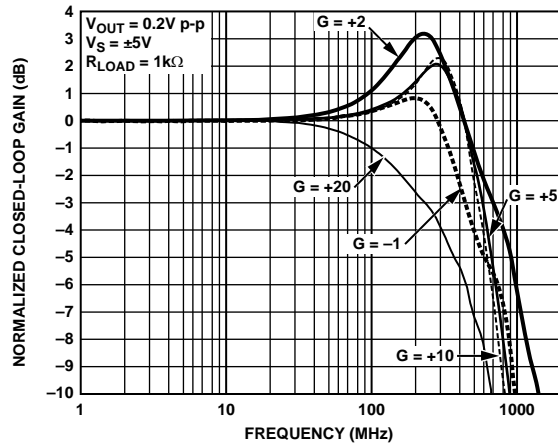

04511-0-073

Figure 8. Small Signal Frequency Response for Various Gains (CSP)

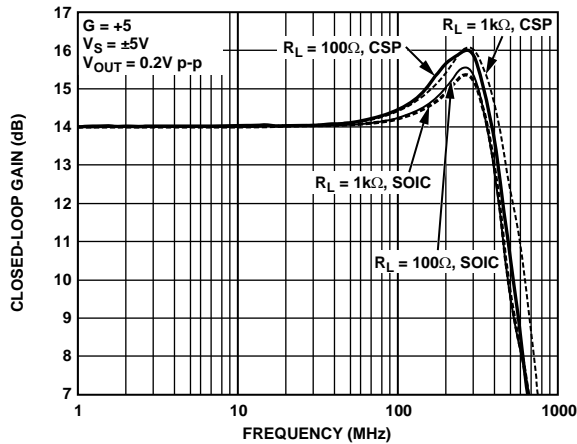

04511-0-076

Figure 6. Small Signal Frequency Response for Various Load Resistors

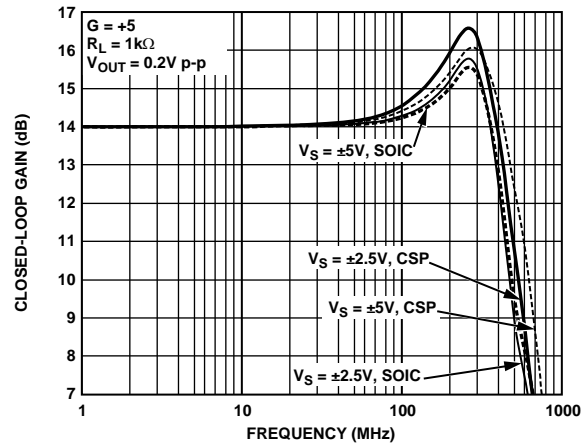

04511-0-077

Figure 9. Small Signal Frequency Response for Various Supply Voltages

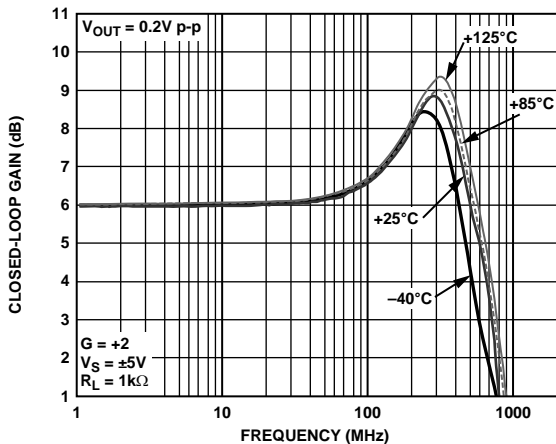

04511-0-088

Figure 7. Small Signal Frequency Response for Various Temperatures (SOIC)

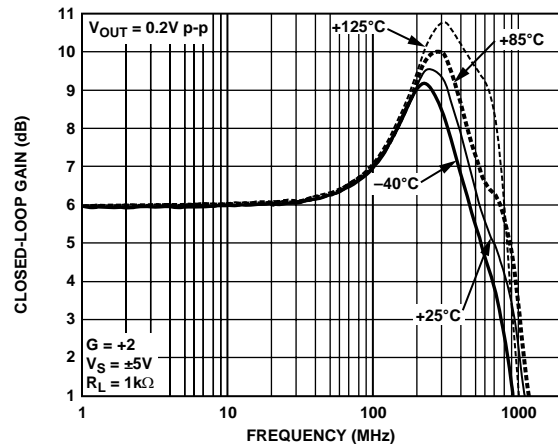

04511-0-087

Figure 10. Small Signal Frequency Response for Various Temperatures (CSP)

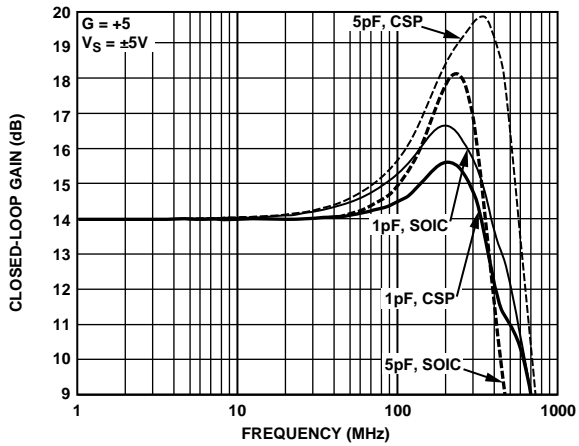

Figure 11. Small Signal Frequency Response for Various Capacitive Loads

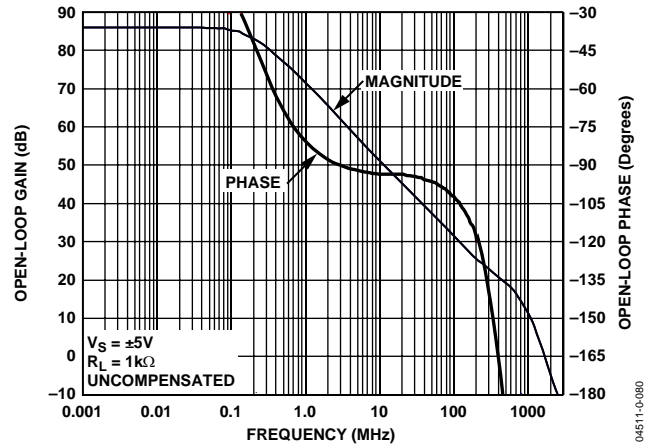

Figure 14. Open Loop Frequency Response

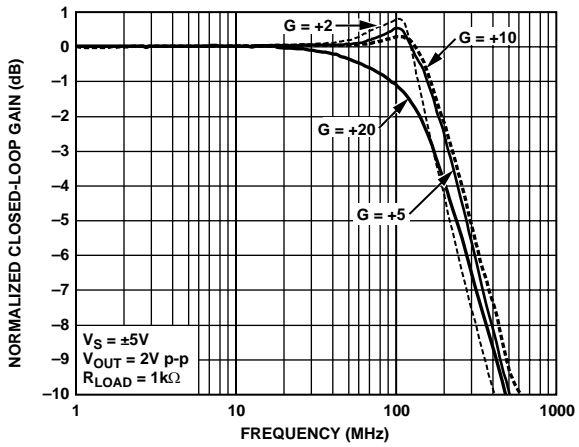

Figure 12. Large Signal Frequency Response for Various Gains (SOIC)

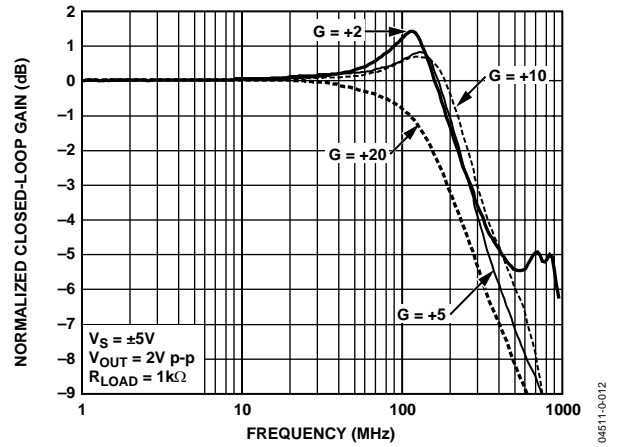

Figure 15. Large Signal Frequency Response for Various Gains (CSP)

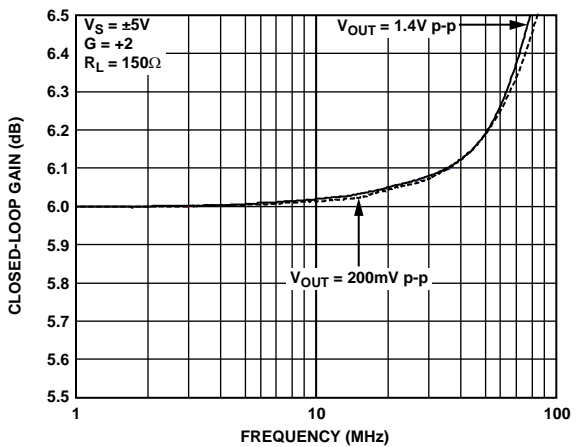

Figure 13. 0.1 dB Flatness (SOIC)

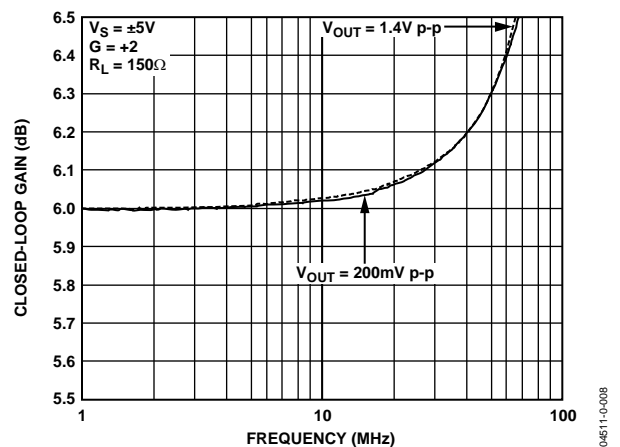

Figure 16. 0.1 dB Flatness (CSP)

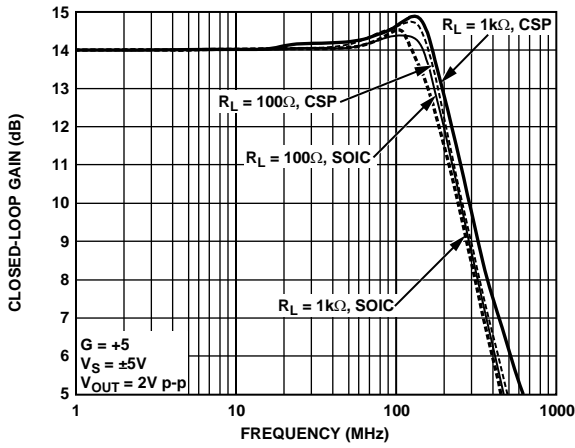

Figure 17. Large Signal Frequency Response for Various Load Resistances

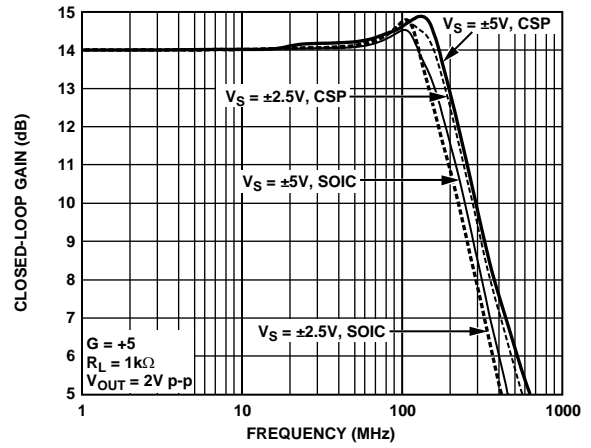

Figure 20. Large Signal Frequency Response for Various Supply Voltages

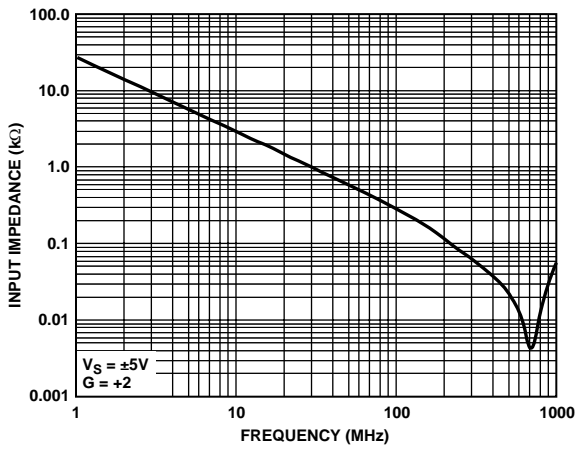

Figure 18. Input Impedance vs. Frequency

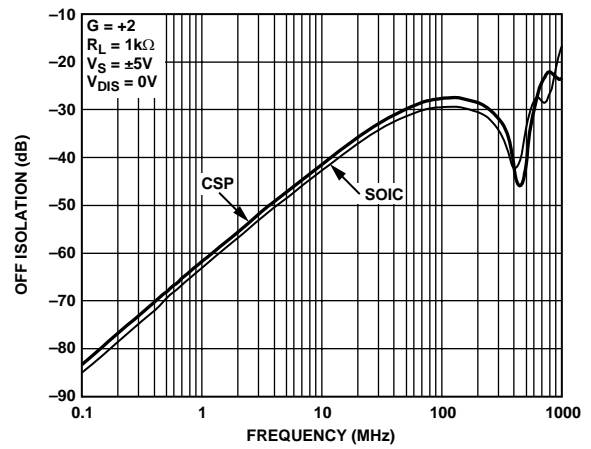

Figure 21. Off Isolation vs. Frequency

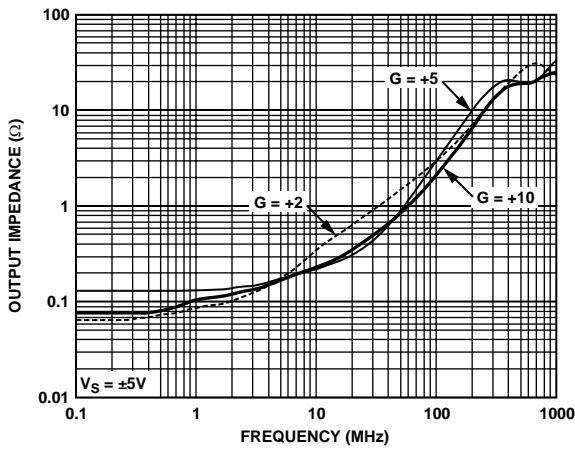

Figure 19. Output Impedance vs. Frequency for Various Gains

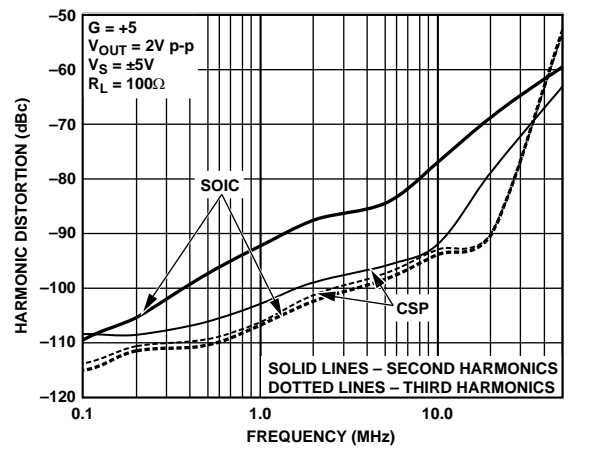

Figure 22. Harmonic Distortion vs. Frequency

04511-0-078

04511-0-078

04511-0-106

04511-0-084

04511-0-100

04511-A-008



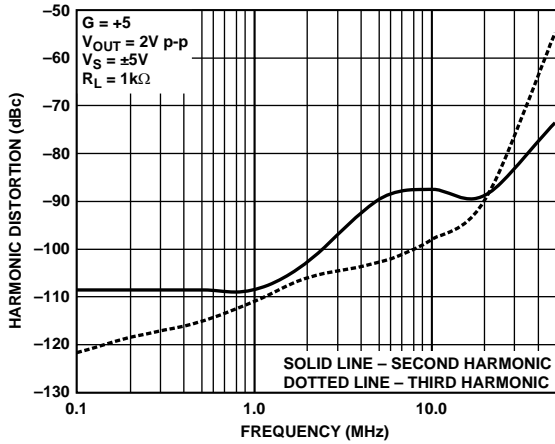

Figure 23. Harmonic Distortion vs. Frequency (SOIC)

04511-A-009

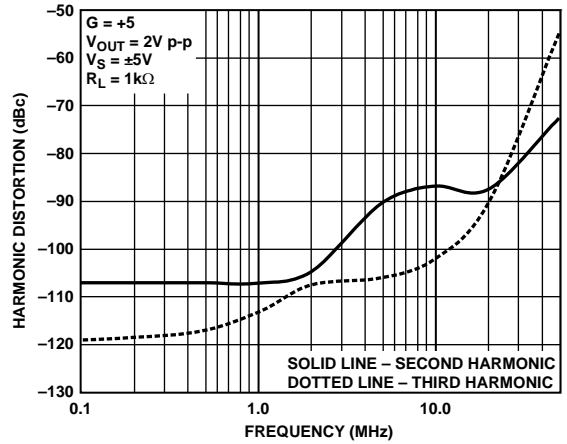

Figure 26. Harmonic Distortion vs. Frequency (CSP)

04511-A-012

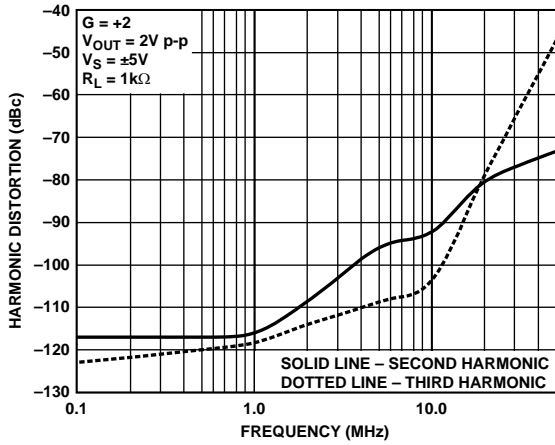

Figure 24. Harmonic Distortion vs. Frequency (SOIC)

04511-A-010

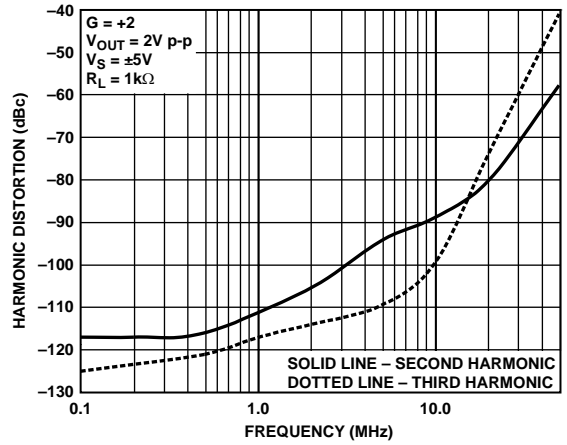

Figure 27. Harmonic Distortion vs. Frequency (CSP)

04511-A-013

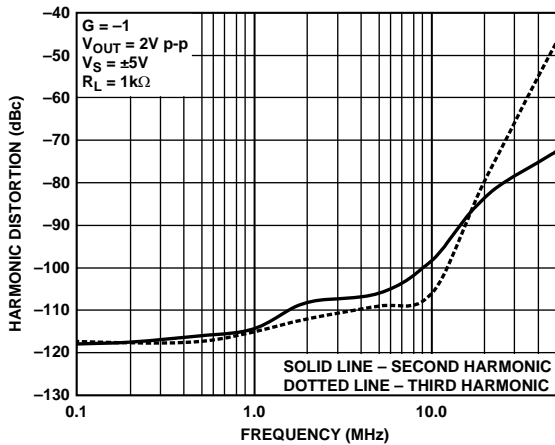

Figure 25. Harmonic Distortion vs. Frequency (SOIC)

04511-A-011

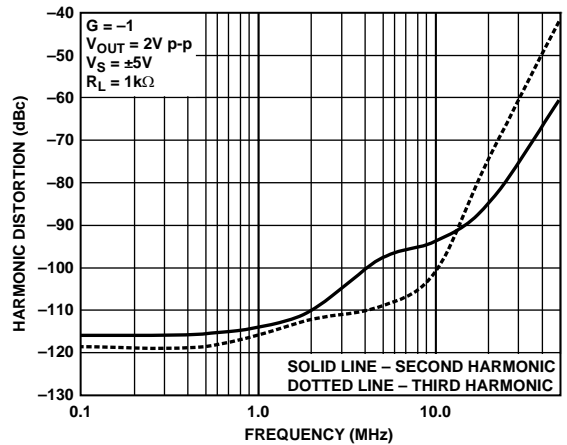
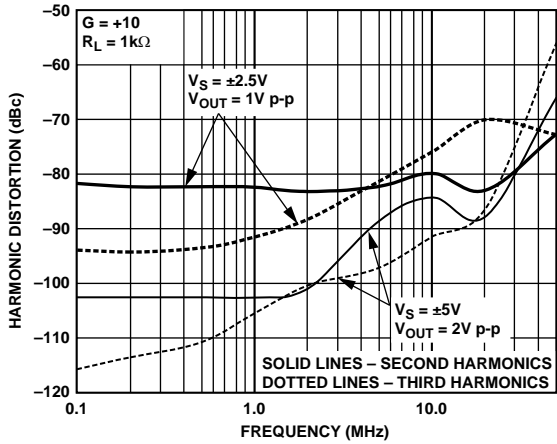

Figure 28. Harmonic Distortion vs. Frequency (CSP)

04511-A-014



04511-A-015

Figure 29. Harmonic Distortion vs. Frequency and Supply Voltage (SOIC)

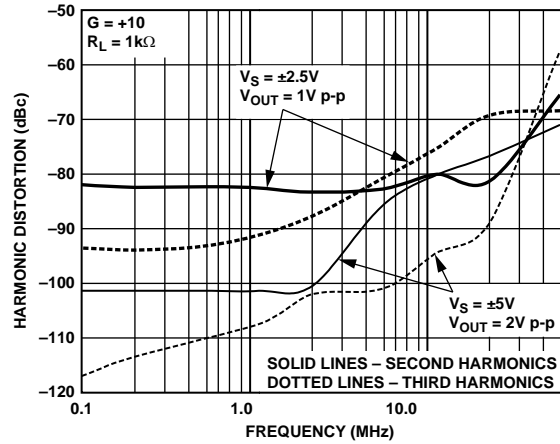

04511-A-018

Figure 32. Harmonic Distortion vs. Frequency for Various Supplies (CSP)

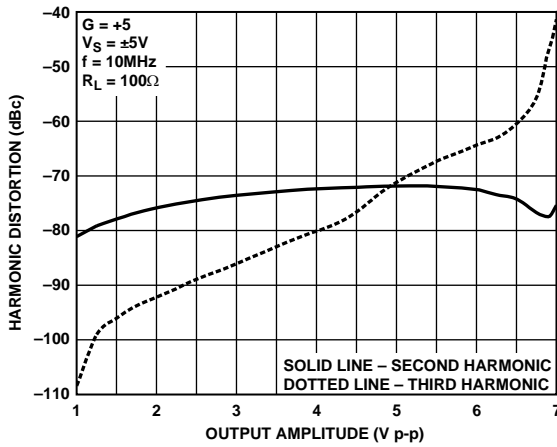

04511-A-016

Figure 30. Harmonic Distortion vs. Output Amplitude (SOIC)

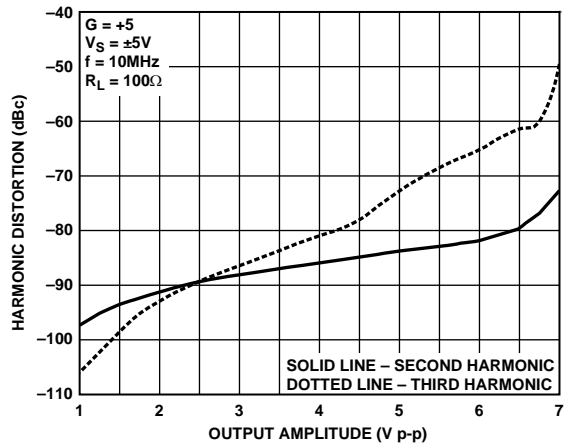

04511-A-019

Figure 33. Harmonic Distortion vs. Output Amplitude (CSP)

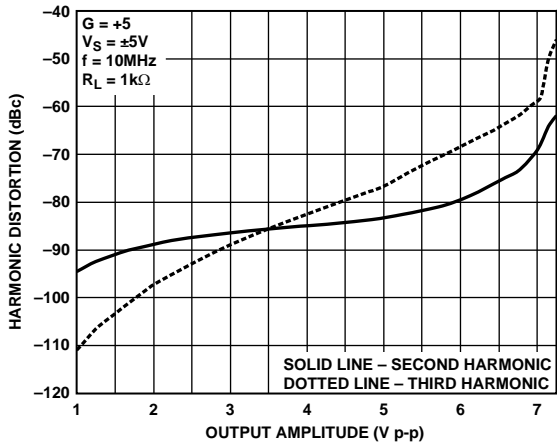

04511-A-017

Figure 31. Harmonic Distortion vs. Output Amplitude (SOIC)

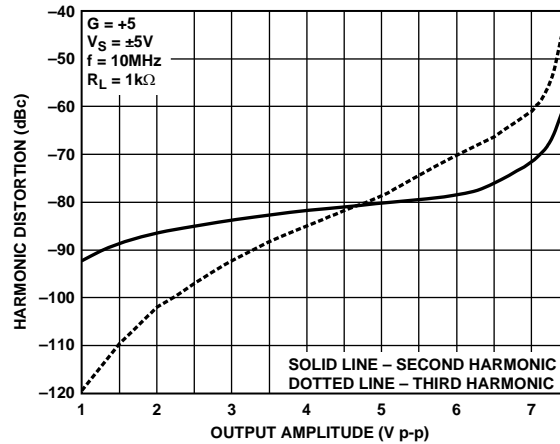

04511-A-021

Figure 34. Harmonic Distortion vs. Output Amplitude (CSP)

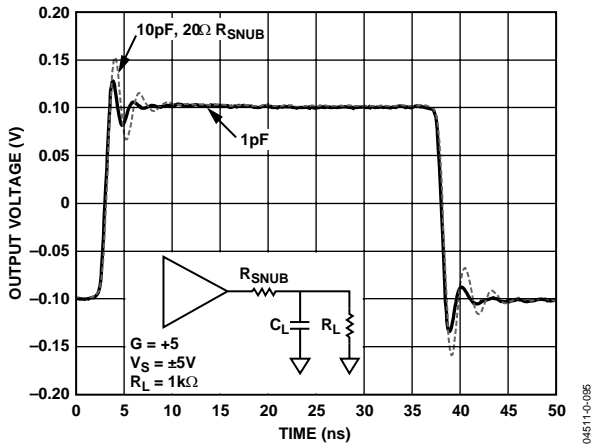

Figure 35. Small Signal Transient Response for Various Capacitive Loads (SOIC)

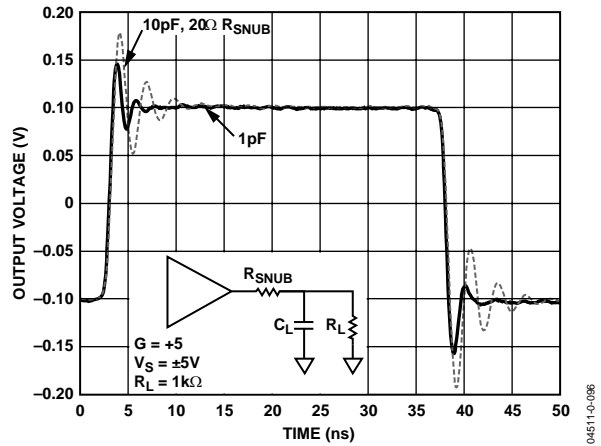

Figure 38. Small Signal Transient Response for Various Capacitive Loads (CSP)

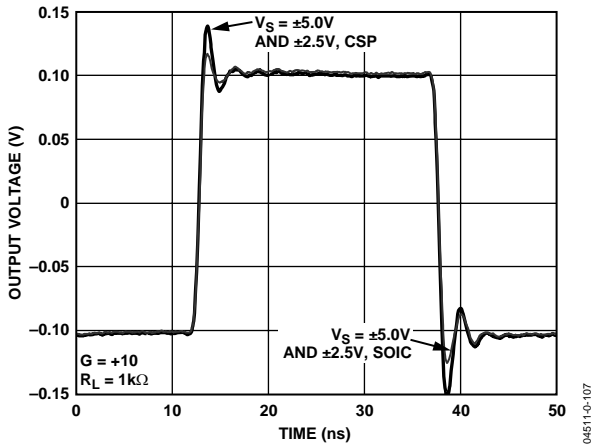

Figure 36. Small Signal Transient Response for Various Supply Voltages

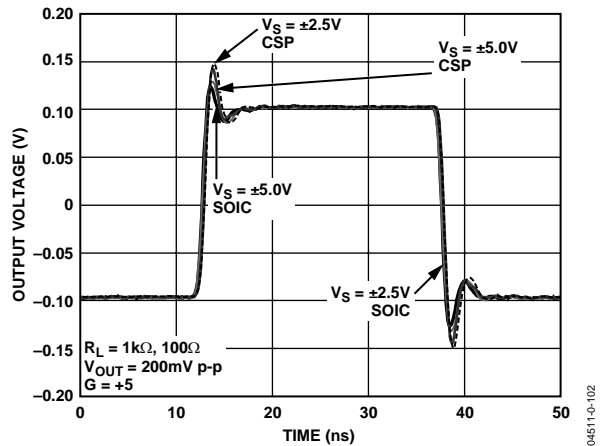

Figure 39. Small Signal Transient Response for Various Supply Voltages

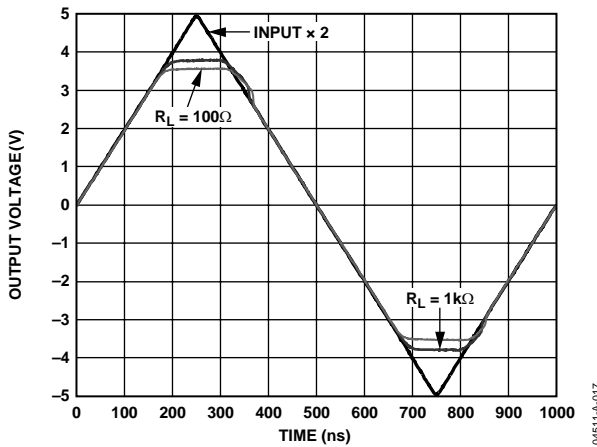

Figure 37. Output Overdrive Recovery for Various Resistive Loads

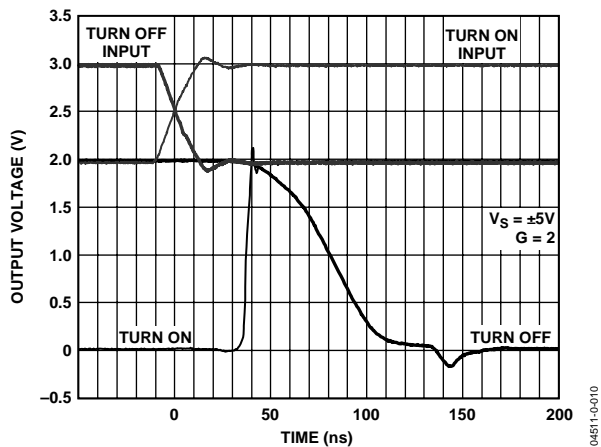

Figure 40. Disable/Enable Switching Speed

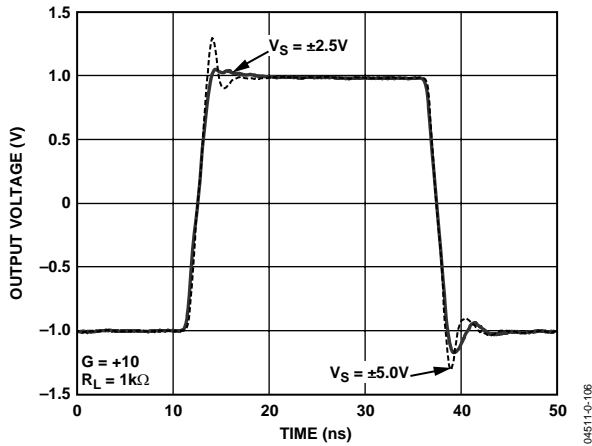

Figure 41. Large Signal Transient Response vs. Supply Voltage (CSP)

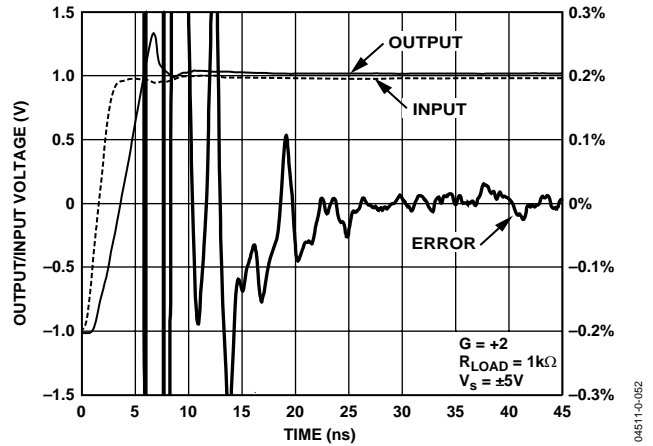

Figure 44. Short Term Settling Time (CSP)

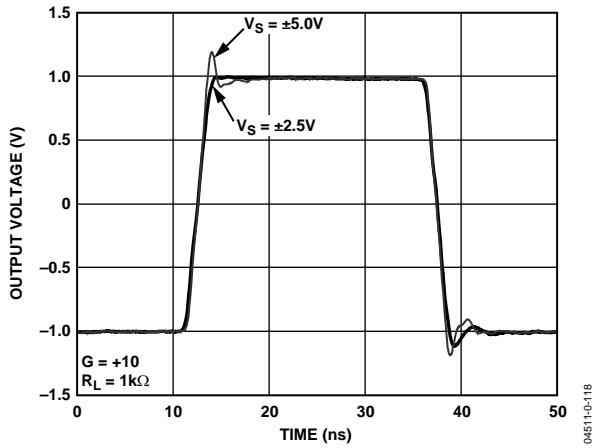

Figure 42. Large Signal Frequency Response vs. Supply Voltage (SOIC)

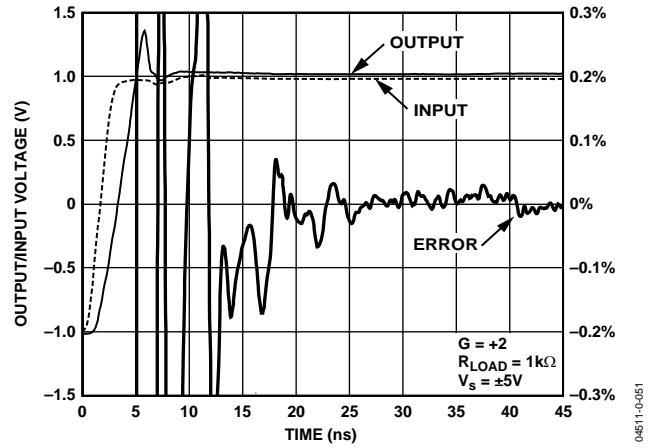

Figure 45. Short Term Settling Time (SOIC)

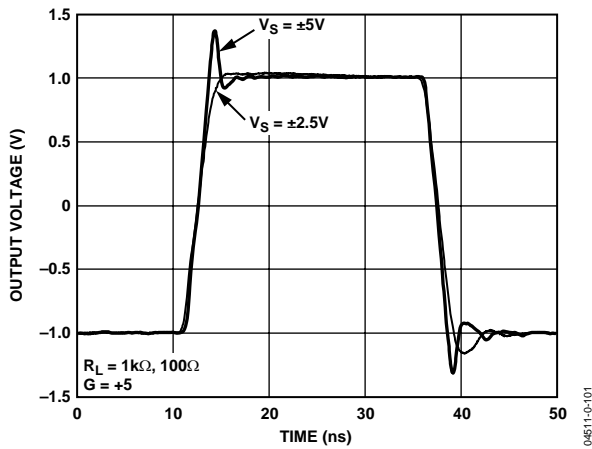

Figure 43. Large Signal Transient Response for Various Supply Voltages and Load Resistances (SOIC and CSP)

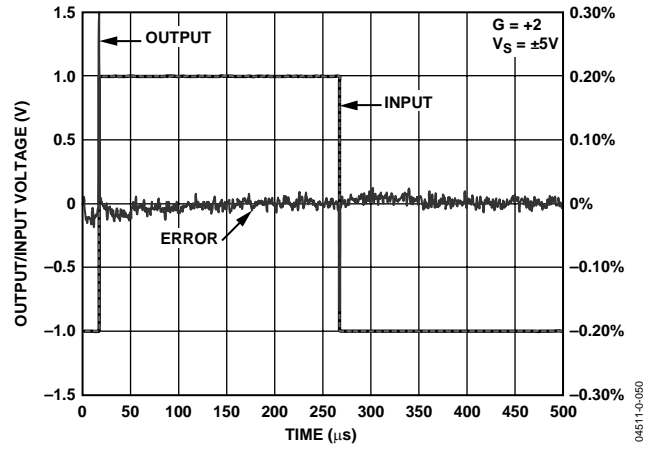

Figure 46. Long Term Settling Time

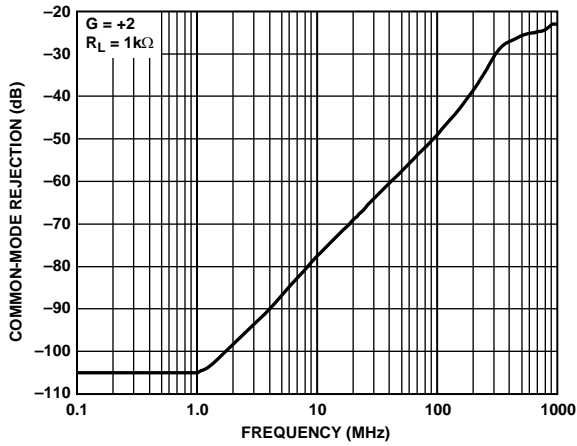

Figure 47. Common-Mode Rejection vs. Frequency

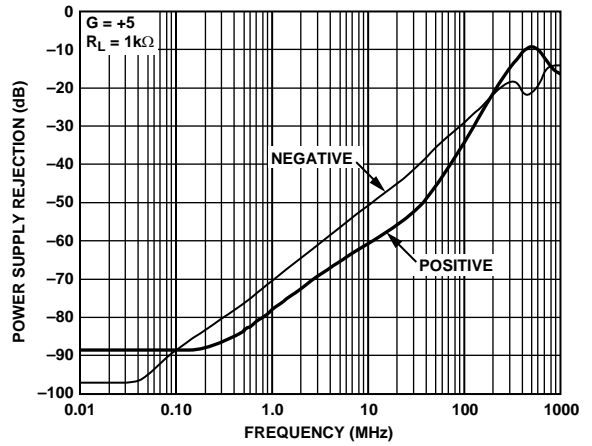

Figure 50. Power Supply Rejection vs. Frequency

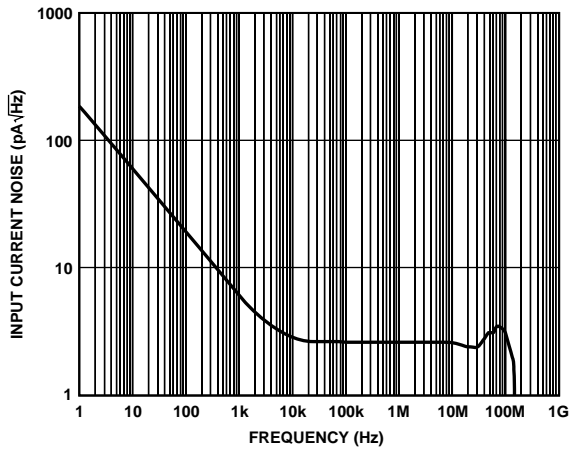

Figure 48. Input Current Noise vs. Frequency ( $\overline{DISABLE} = Open$ )

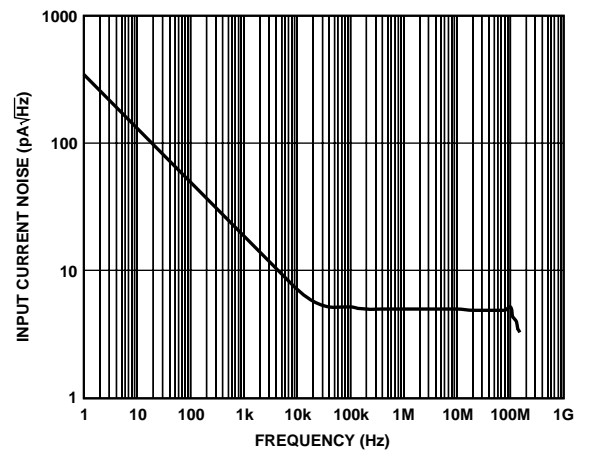

Figure 51. Input Current Noise vs. Frequency ( $\overline{DISABLE} = +V_S$ )

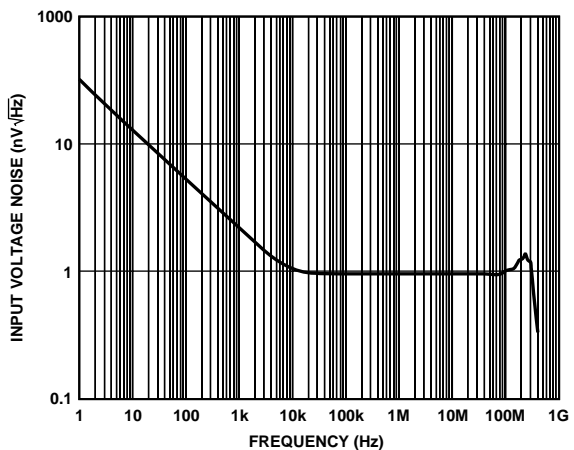

Figure 49. Input Voltage Noise vs. Frequency

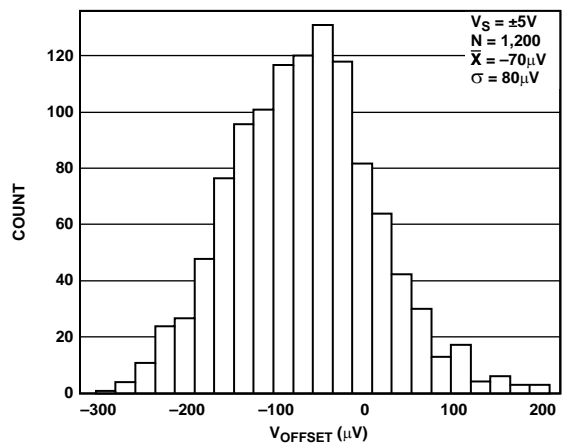

Figure 52. Input Offset Voltage Distribution

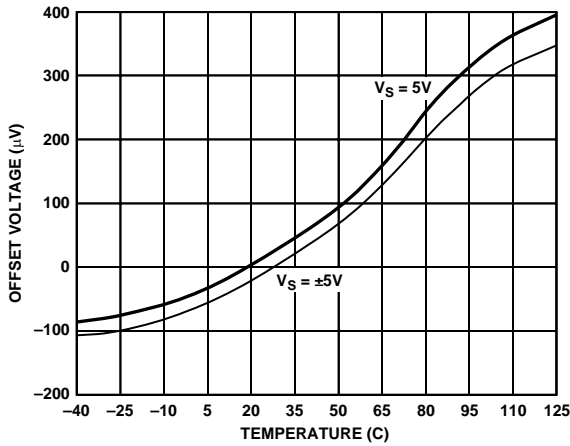

Figure 53. Input Offset Voltage vs. Temperature

04511-A-003

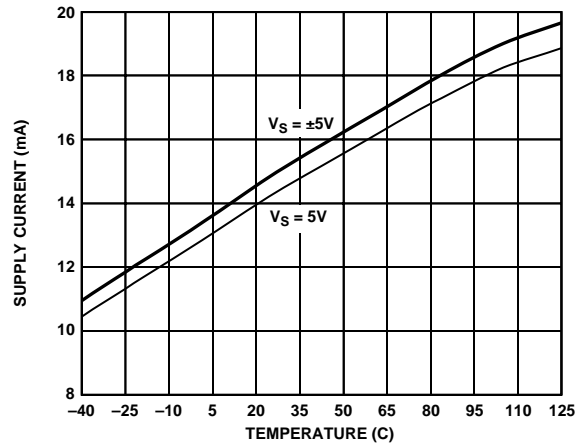

Figure 56. Supply Current vs. Temperature

04511-A-006

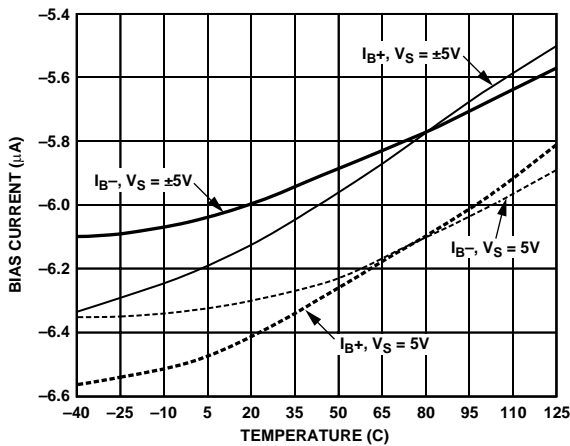

Figure 54. Input Bias Current vs. Temperature ( $\overline{DISABLE}$  Pin Floating)

04511-A-004

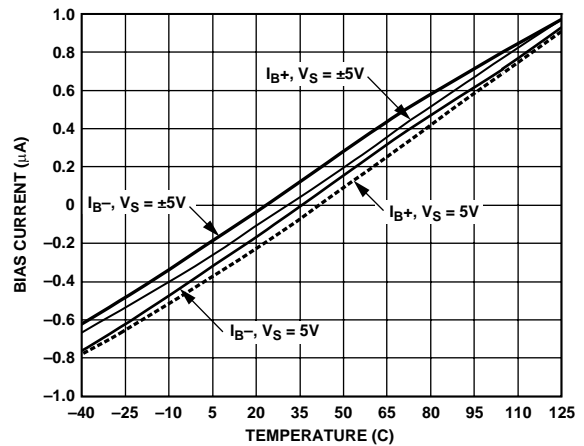

Figure 57. Input Bias Current vs. Temperature ( $\overline{DISABLE}$  Pin =  $+V_S$ )

04511-A-007

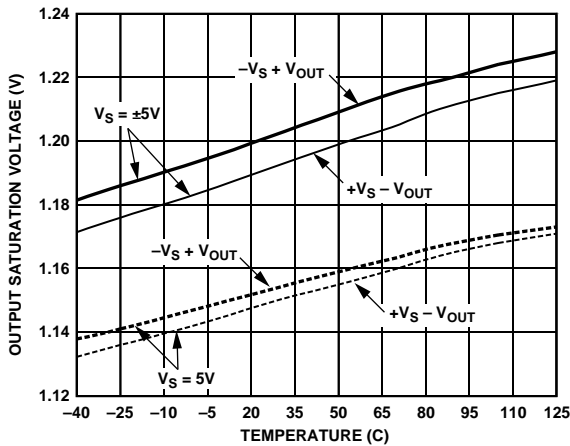

Figure 55. Output Saturation Voltage vs. Temperature

04511-A-005

## THEORY OF OPERATION

The AD8099 is a voltage feedback op amp that employs a new highly linear low noise input stage. With this input stage, the AD8099 can achieve better than 90 dB distortion for a 2 V p-p, 10 MHz output signal with an input referred voltage noise of less than 1 nV/ $\sqrt{\text{Hz}}$ . This noise level and distortion performance has been previously achievable only with fully uncompensated amplifiers. The AD8099 achieves this level of performance for gains as low as +2. This new input stage also triples the achievable slew rate for comparably compensated 1 nV/ $\sqrt{\text{Hz}}$  amplifiers.

The simplified AD8099 topology is shown in Figure 58. The amplifier is a single gain stage with a unity gain output buffer fabricated in Analog Devices' extra fast complimentary bipolar process (XFCB). The AD8099 has 85 dB of open-loop gain and maintains precision specifications such as CMRR, PSRR,  $V_{OS}$ , and  $\Delta V_{OS}/\Delta T$  to levels that are normally associated with topologies having two or more gain stages.

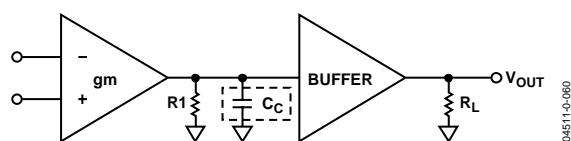

Figure 58. AD8099 Topology

The AD8099 can be externally compensated down to a gain of 2 through the use of an RC network. Above gains of 15, no external compensation network is required. To realize the full gain bandwidth product of the AD8099, no PCB trace should be connected to or within close proximity of the external compensation pin for the lowest possible capacitance.

External compensation allows the user to optimize the closed-loop response for minimal peaking while increasing the gain bandwidth product in higher gains, lowering distortion errors that are normally more prominent with internally compensated parts in higher gains. For a fixed gain bandwidth, wideband distortion products would normally increase by 6 dB going from a closed-loop gain of 2 to 4. Increasing the gain bandwidth product of the AD8099 eliminates this effect with increasing closed-loop gain.

The AD8099 is available in both a SOIC and an LFCSP, each of which has a thermal pad for lower operating temperature. To help avoid this pad in board layout, both packages have an extra output pin on the opposite side of the package for ease in connecting a feedback network to the inputs. The secondary output pin also isolates the interaction of any capacitive load on the

output and self-inductance of the package and bond wire from the feedback loop. While using the secondary output for feedback, inductance in the primary output will now help to isolate capacitive loads from the output impedance of the amplifier. Since the SOIC has greater inductance in its output, the SOIC will drive capacitive loads better than the LFCSP. Using the primary output for feedback with both packages will result in the LFCSP driving capacitive load better than the SOIC.

The LFCSP and SOIC pinouts are identical, except for the rotation of all pins counterclockwise by one pin on the LFCSP. This isolates the inputs from the negative power supply pin, removing a mutually inductive coupling that is most prominent while driving heavy loads. For this reason, the LFCSP second harmonic, while driving a heavy load, is significantly better than that of the SOIC.

A three-state input pin is provided on the AD8099 for a high impedance power-down and an optional input bias current cancellation circuit. The high impedance output allows several AD8099s to drive the same ADC or output line time interleaved. Pulling the DISABLE pin low activates the high impedance state. See Table 5 for threshold levels. When the DISABLE pin is left floating, the AD8099 operates normally. With the DISABLE pin pulled within 0.7 V of the positive supply, an optional input bias current cancellation circuit is turned on, which lowers the input bias current to less than 200 nA. In this mode, the user can drive the AD8099 with a high dc source impedance and still maintain minimal output referred offset without having to use impedance matching techniques. In addition, the AD8099 can be ac-coupled while setting the bias point on the input with a high dc impedance network. The input bias current cancellation circuit will double the input referred current noise, but this effect is minimal as long as wideband impedance is kept low (see Figure 48 and Figure 51).

A pair of internally connected diodes limits the differential voltage between the noninverting input and the inverting input of the AD8099. Each set of diodes has two series diodes, which are connected in anti-parallel. This limits the differential voltage between the inputs to approximately  $\pm 1.8$  V. All of the AD8099 pins are ESD protected with voltage limiting diodes connected between both rails. The protection diodes can handle 5 mA of steady state current. Currents should be limited to 5 mA or less through the use of a series limiting resistor.

## APPLICATIONS

### USING THE AD8099

The AD8099 offers unrivaled noise and distortion performance in low signal gain configurations. In low gain configurations (less than 15), the AD8099 requires external compensation. The amount of gain and performance needed will determine the compensation network.

Understanding the subtleties of the AD8099 gives the user insight on how to exact its peak performance. Use the component values and circuit configurations shown in the Applications section as starting points for designs. Specific circuit applications will dictate the final configuration and value of your components.

### CIRCUIT COMPONENTS

The circuit components are referenced in Figure 59, the recommended noninverting circuit schematic for the AD8099. See Table 4 for typical component values and performance data.

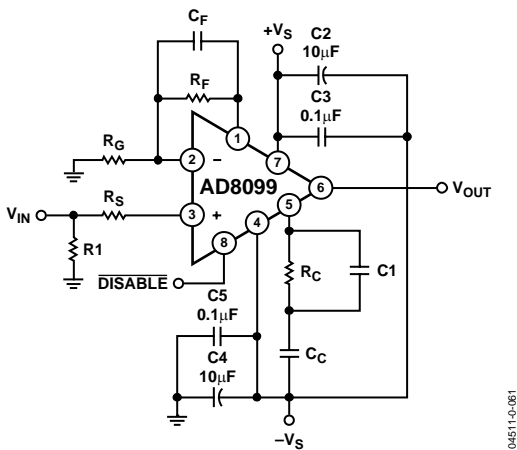

Figure 59. Wideband Noninverting Gain Configuration (SOIC)

**R<sub>F</sub> and R<sub>G</sub>**—The feedback resistor and the gain set resistor determine the noise gain of the amplifier; typical R<sub>F</sub> values range from 250 Ω to 499 Ω.

**C<sub>F</sub>**—Creates a zero in the loop response to compensate the pole created by the input capacitance (including stray capacitance) and the feedback resistor R<sub>F</sub>. C<sub>F</sub> helps reduce high frequency peaking and ringing in the closed-loop response. Typical range is 0.5 pF to 1.5 pF for evaluation circuits used here.

**R<sub>1</sub>**—This resistor terminates the input of the amplifier to the source resistance of the signal source, typically 50 Ω. (This is application specific and not always required.)

**R<sub>S</sub>**—Many high speed amplifiers in low gain configurations require that the input stage be terminated into a nominal impedance to maintain stability. The value of R<sub>S</sub> should be kept to 50 Ω or lower to maintain low noise performance. At higher gains, R<sub>S</sub> may be reduced or even eliminated. Typical range is 0 Ω to 50 Ω.

**C<sub>C</sub>**—The compensation capacitor decreases the open-loop gain at higher frequencies where the phase is degrading. By decreasing the open-loop gain here, the phase margin is increased and the amplifier is stabilized. Typical range is 0 pF to 5 pF. The value of C<sub>C</sub> is gain dependent.

**R<sub>C</sub>**—The series lead inductance of the package and the compensation capacitance (C<sub>C</sub>) forms a series resonant circuit. R<sub>C</sub> dampens this resonance and prevents oscillations. The recommended value of R<sub>C</sub> is 50 Ω for a closed-loop gain of 2. This resistor introduces a zero in the open-loop response and must be kept low so that this zero occurs at a higher frequency. The purpose of the compensation network is to decrease the open-loop gain. If the resistance becomes too large, the gain will be reduced to the resistor value, and not necessarily to 0 Ω, which is what a single capacitor would do over frequency. Typical value range is 0 Ω to 50 Ω.

**C<sub>1</sub>**—To lower the impedance of R<sub>C</sub>, C<sub>1</sub> is placed in parallel with R<sub>C</sub>. C<sub>1</sub> is not required, but greatly reduces peaking at low closed-loop gains. The typical value range is 0 pF to 2 pF.

**C<sub>2</sub> and C<sub>3</sub>**—Bypass capacitors are connected **between** both supplies for optimum distortion and PSRR performance. These capacitors should be placed as close as possible to the supply pins of the amplifier. For **C<sub>3</sub>**, **C<sub>5</sub>**, a 0508 case size should be used. The 0508 case size offers reduced inductance and better frequency response.

**C<sub>4</sub> and C<sub>2</sub>**—Electrolytic bypass capacitors.



**RECOMMENDED VALUES**

Table 4. Recommended Values and AD8099 Performance

Gain	Package	Feedback Network Values				Compensation Network Values			-3 dB SS Bandwidth (MHz)	Slew Rate (V/ $\mu$ s)	Peaking (dB)	Output Noise (AD8099 Only) (nV/ $\sqrt$ Hz)	Total Output Noise Including Resistors (nV/ $\sqrt$ Hz)
		R <sub>F</sub>	R <sub>G</sub>	R <sub>S</sub>	C <sub>F</sub>	R <sub>C</sub>	C <sub>C</sub>	C <sub>1</sub>					
-1, 2	SOIC	250	250	50	1.5	50	4	1.5	440/700	515	0.3/3.1	2.1	4
2	CSP	250	250	50	0.5	50	5	2	700	475	3.2	2.1	4
-1	CSP	250	250	50	1.0	50	5	2	420	475	0.8	2.1	4
5	CSP/SOIC	499	124	20	0.5	50	1	0	510	735	1.4	4.9	8.6
10	CSP/SOIC	499	54	0	0	0	0.5	0	550	1350	0.8	9.6	13.3
20	CSP/SOIC	499	26	0	0	0	0	0	160	1450	0	19	23.3

**CIRCUIT CONFIGURATIONS**

Figure 60 through Figure 66 show typical schematics for the AD8099 in various gain configurations. Table 4 data was collected using the schematics shown in Figure 60 through Figure 66. Resistor R1, as shown in Figure 60 through Figure 66,

is the test equipment termination resistor. R1 is **not** required for normal operation, but is shown in the schematics for completeness.

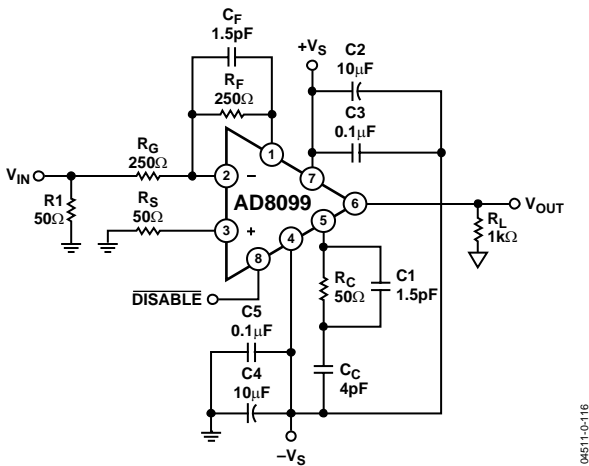

Figure 60. Amplifier Configuration for SOIC Package, Gain = -1

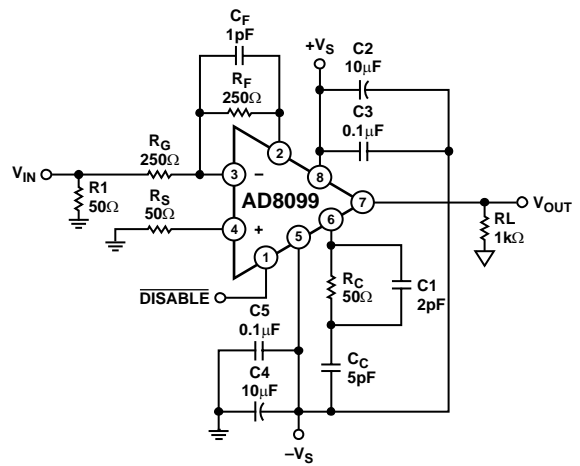

Figure 62. Amplifier Configuration for CSP Package, Gain = -1

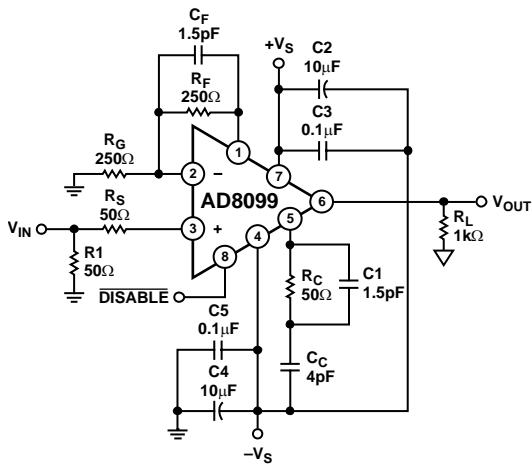

Figure 61. Amplifier Configuration for SOIC Package, Gain = +2

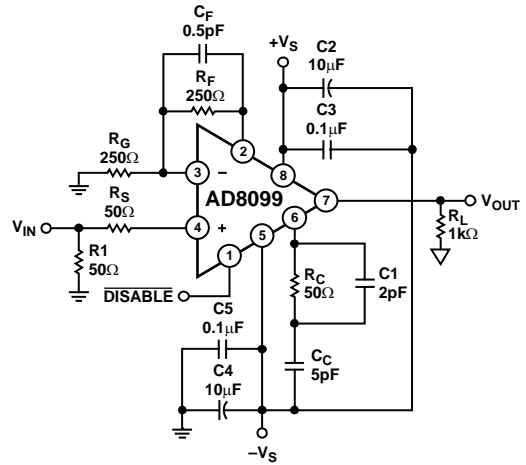
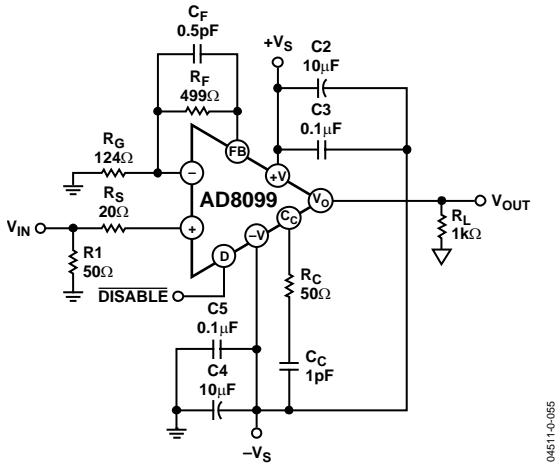

Figure 63. Amplifier Configuration for CSP Package, Gain = +2

# AD8099



04511-0-055

Figure 64. Amplifier Configuration for CSP and SOIC Package, Gain = +5

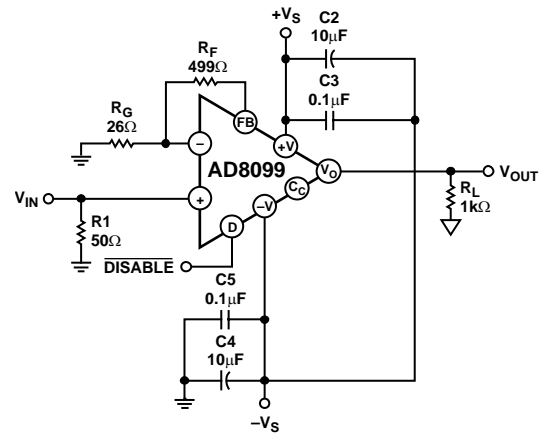

04511-0-057

Figure 66. Amplifier Configuration for CSP and SOIC Packages, Gain = +20

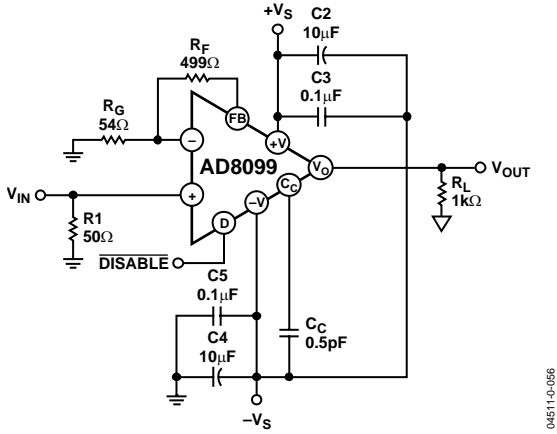

04511-0-056

Figure 65. Amplifier Configuration for CSP and SOIC Packages, Gain = +10

**PERFORMANCE VS. COMPONENT VALUES**

The influence that each component has on the AD8099 frequency response can be seen in Figure 67 and Figure 68. In Figure 67 and Figure 68, all component values are held constant, except for the individual component shown, which is varied. For example, in the  $R_s$  performance plot of Figure 68, all components are held constant except  $R_s$ , which is varied from  $0\ \Omega$  to  $50\ \Omega$ ; and clearly indicates that  $R_s$  has a major influence on peaking and bandwidth of the AD8099.

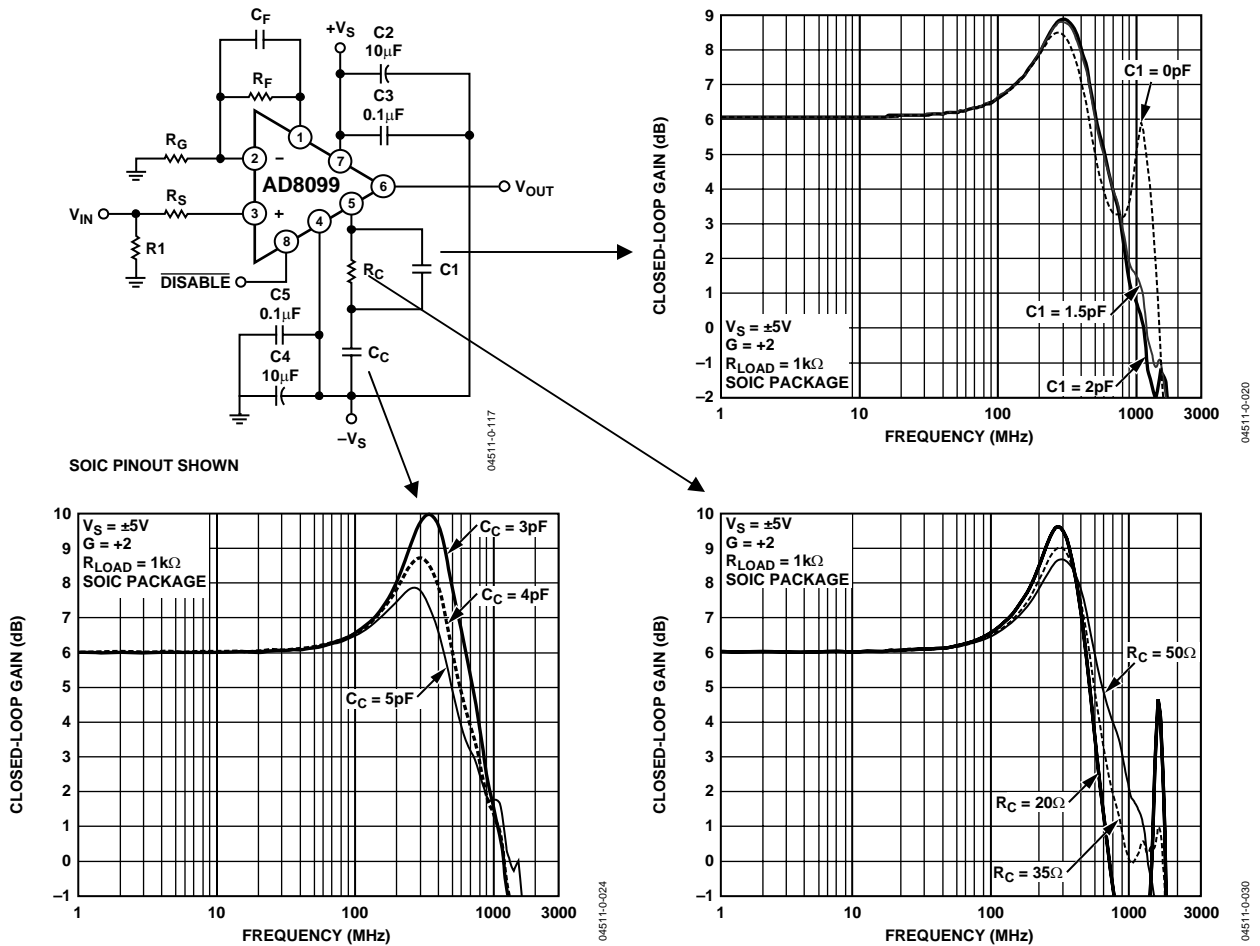

Figure 67. Frequency Response for Various Values of  $C_1$ ,  $C_C$ ,  $R_C$

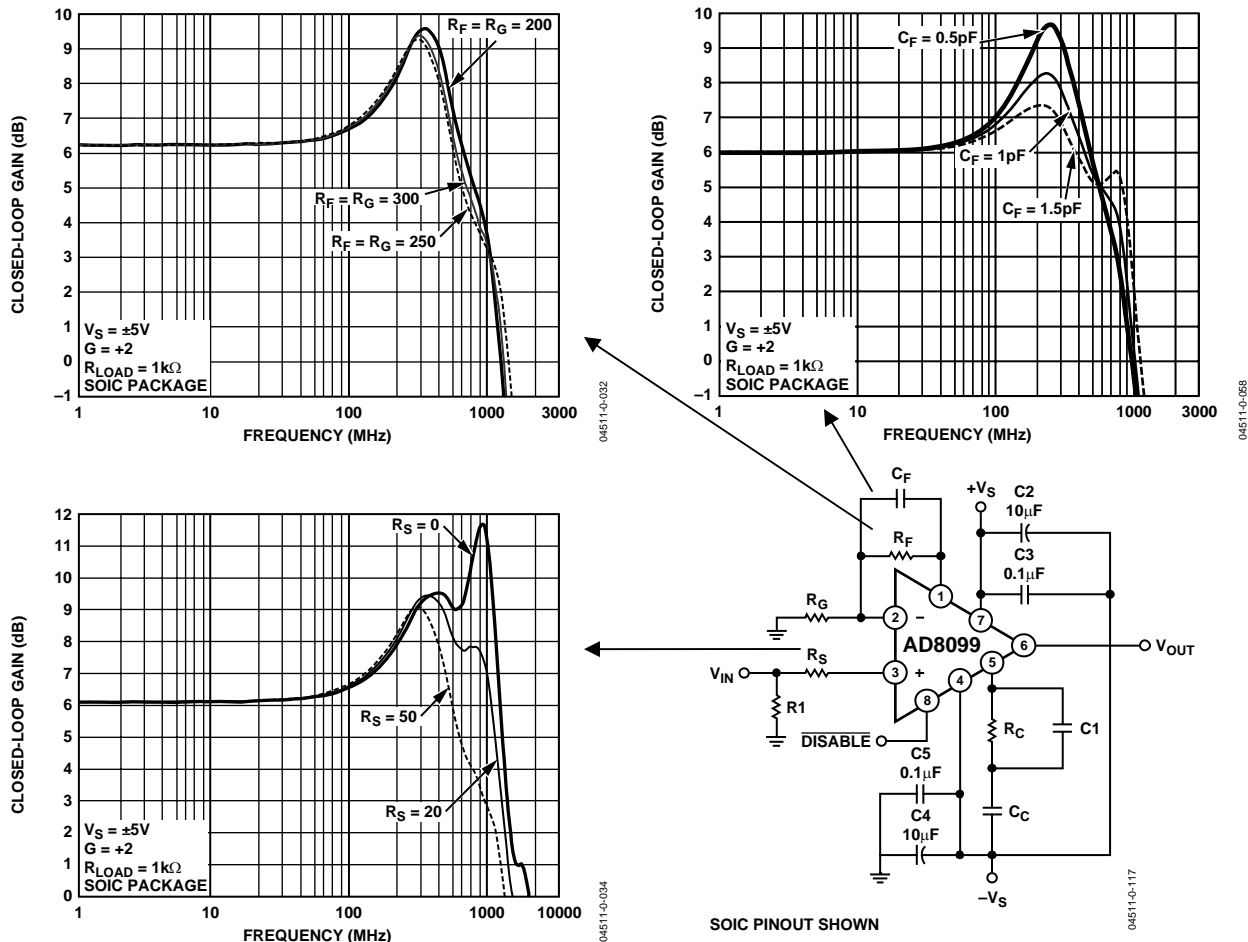

Figure 68. Frequency Response for Various Values of  $R_f$ ,  $C_f$ ,  $R_s$

## TOTAL OUTPUT NOISE CALCULATIONS AND DESIGN

To analyze the noise performance of an amplifier circuit, the individual noise sources must be identified. Then determine if the source has a significant contribution to overall noise performance of the amplifier. To simplify the noise calculations, we will work with noise spectral densities, rather than actual voltages to leave bandwidth out of the expressions (noise spectral density, which is generally expressed in  $nV/\sqrt{Hz}$ , is equivalent to the noise in a 1 Hz bandwidth).

The noise model shown in Figure 69 has six individual noise sources: the Johnson noise of the three resistors, the op amp voltage noise, and the current noise in each input of the amplifier. Each noise source has its own contribution to the

noise at the output. Noise is generally specified RTI (referred to input), but it is often simpler to calculate the noise referred to the output (RTO) and then divide by the noise gain to obtain the RTI noise.

All resistors have a Johnson noise of  $\sqrt{4k_BTR}$ , where  $k$  is Boltzmann's Constant ( $1.38 \times 10^{-23}$  J/K),  $T$  is the absolute temperature in Kelvin,  $B$  is the bandwidth in Hz, and  $R$  is the resistance in ohms. A simple relationship, which is easy to remember, is that a  $50 \Omega$  resistor generates a Johnson noise of  $1 nV/\sqrt{Hz}$  at  $25^\circ C$ . The AD8099 amplifier has roughly the same equivalent noise as a  $50 \Omega$  resistor.

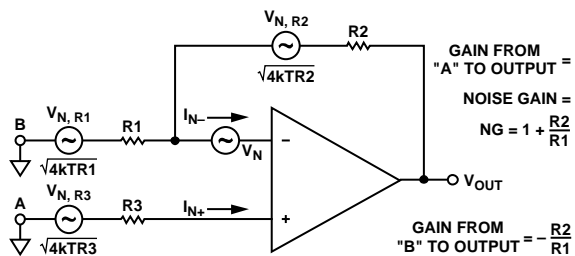

$$\text{RTI NOISE} = \sqrt{V_N^2 + 4kTR_3 + 4kTR_1 \left[ \frac{R_2}{R_1 + R_2} \right]^2 + I_{N+}^2 R_3^2 + I_{N-}^2 \left[ \frac{R_1 \times R_2}{R_1 + R_2} \right]^2 + 4kTR_2 \left[ \frac{R_1}{R_1 + R_2} \right]^2}$$

$$\text{RTO NOISE} = \text{NG} \times \text{RTI NOISE}$$

04511-0-070

Figure 69. Op Amp Noise Analysis Model

In applications where noise sensitivity is critical, care must be taken not to introduce other significant noise sources to the amplifier. Each resistor is a noise source. Attention to the following areas is critical to maintain low noise performance: design, layout, and component selection. A summary of noise performance for the amplifier and associated resistors can be seen in Table 4.

### INPUT BIAS CURRENT AND DC OFFSET

In high noise gain configurations, the effects of output offset voltage can be significant, even with low input bias currents and input offset voltages. Figure 70 shows a comprehensive offset voltage model, which can be used to determine the referred to output (RTO) offset voltage of the amplifier or referred to input (RTI) offset voltage.

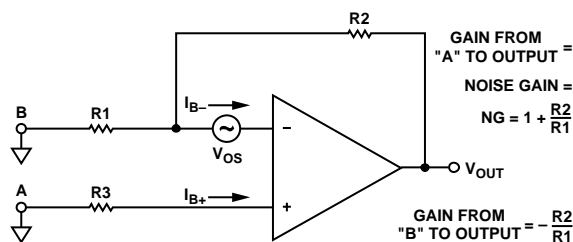

$$\text{OFFSET (RTO)} = V_{OS} \left[ 1 + \frac{R_2}{R_1} \right] + I_{B+} \times R_3 \left[ 1 + \frac{R_2}{R_1} \right] - I_{B-} \times R_2$$

$$\text{OFFSET (RTI)} = V_{OS} + I_{B+} \times R_3 - I_{B-} \left[ \frac{R_1 \times R_2}{R_1 + R_2} \right]$$

FOR BIAS CURRENT CANCELLATION:

$$\text{OFFSET (RTI)} = V_{OS} \quad \text{IF } I_{B+} = I_{B-} \text{ AND } R_3 = \left[ \frac{R_1 \times R_2}{R_1 + R_2} \right]$$

04511-0-071

Figure 70. Op Amp Total Offset Voltage Model

For RTO calculations, the input offset voltage and the voltage generated by the bias current flowing through R3 are multiplied by the noise gain of the amplifier. The voltage generated by  $I_{B-}$  through R2 is summed together with the previous offset voltages to arrive at a final output offset voltage. The offset voltage can also be referred to the input (RTI) by dividing the calculated output offset voltage by the noise gain.

As seen in Figure 70 if  $I_{B+}$  and  $I_{B-}$  are the same and R3 equals the parallel combination of R1 and R2, then the RTI offset voltage can be reduced to only  $V_{OS}$ . This is a common method used to reduce output offset voltage. Keeping resistances low helps to minimize offset error voltage and keeps the voltage noise low.

### DISABLE PIN AND INPUT BIAS CANCELLATION

The AD8099 DISABLE pin performs three functions; enable, disable, and reduction of the input bias current. When the DISABLE pin is brought to within 0.7 V of the positive supply, the input bias current is reduced by an approximate factor of 60. However, the input current noise doubles to 5.2 pA/ $\sqrt{\text{Hz}}$ . Table 5 outlines the DISABLE pin functionality.

Table 5. DISABLE Pin Truth Table

Supply Voltage	$\pm 5$ V	+5 V
Disable	-5 to +2.4	0 to 2.4
Enable	Open	Open
Low Input Bias Current	4.3 to 5	4.3 to 5

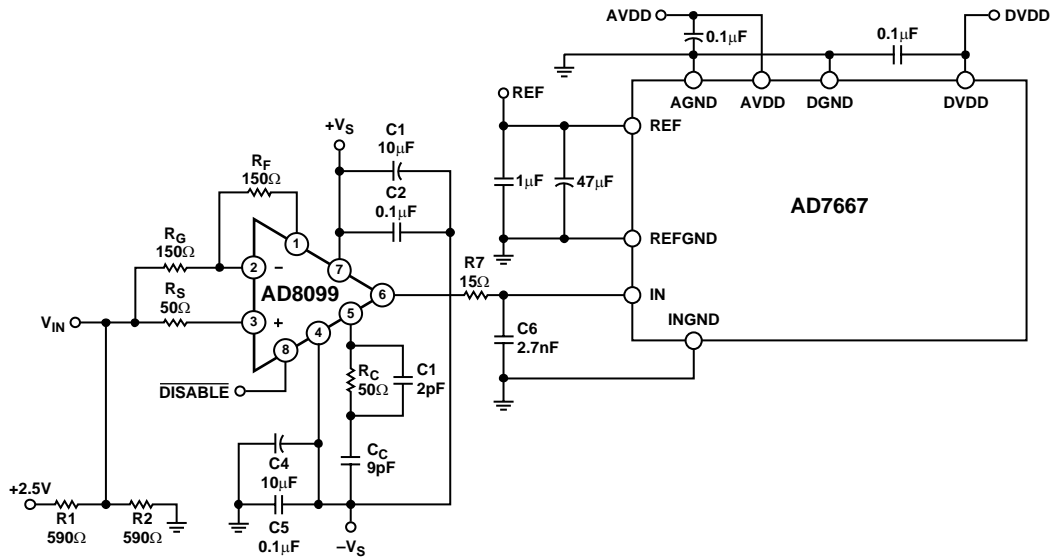

Figure 71. ADC Driver

## 16-BIT ADC DRIVER

Ultralow noise and distortion performance make the AD8099 an ideal ADC driver. Even though the AD8099 is not unity gain stable, it can be configured to produce a net gain of +1 amplifier, as shown in Figure 71. This is achieved by combining a gain of +2 and a gain of -1 for a net gain of +1. The input range of the ADC is 0 V to 2.5 V.

Table 6 shows the performance data of the AD8099 and the Analog Devices [AD7667](#) a 1 MSPS 16-bit ADC.

**Table 6. ADC Driver Performance,  $f_c = 20$  kHz,  $V_{OUT} = 2.24$  V p-p**

Parameter	Measurement (dB)
Second Harmonic Distortion	-111.4
Third Harmonic Distortion	-103.2
THD	-101.4
SFDR	102.2
SNR	88.1

## CIRCUIT CONSIDERATIONS

Optimizing the performance of the AD8099 requires attention to detail in layout and signal routing of the board. Power supply bypassing, parasitic capacitance, and component selection all contribute to the overall performance of the amplifier. The AD8099 features an exposed paddle on the backs of both the CSP and SOIC packages. The exposed paddle provides a low thermal **resistive** path to the ground plane. For best performance, solder the exposed paddle to the ground plane.

### PCB Layout

The compensation network is determined by the amplifier gain requirements. For lower gains, the layout and component placement are more critical. For higher gains, there are fewer compensation components, which results in a less complex layout. With diligent consideration to layout, grounding, and component placement, the AD8099 evaluation boards have been optimized for peak performance. These are the same evaluation boards that are available to customers; see Table 7 for ordering information. The noninverting evaluation board artwork for SOIC and CSP layouts are shown in Figure 72 and Figure 73. Incorporating the layout information shown in Figure 72 and Figure 73 into new designs is highly recommended and helps to ensure optimal circuit performance. The concepts of layout, grounding, and component placement, illustrated in Figure 72 and Figure 73, also apply to inverting configurations. For scale, the boards are 2" × 2".

### Parasitics

The area surrounding the compensation pin is very sensitive to parasitic capacitance. To realize the full gain bandwidth product of the AD8099, there should be no trace connected to or within close proximity of the external compensation pin for the lowest possible capacitance. When compensation is required, the traces to the compensation pin, the negative supply, and the interconnect between components (i.e.  $C_c$ ,  $C_1$ , and  $R_c$  in Figure 59) should be made as wide as possible to minimize inductance.

All ground and power planes under the pins of the AD8099 should be cleared of copper to prevent parasitic capacitance between the input and output pins to ground. A single mounting pad on a SOIC footprint can add as much as 0.2 pF of capacitance to ground as a result of not clearing the ground or power plane under the AD8099 pins. Parasitic capacitance can cause peaking and instability, and should be minimized to ensure proper operation.

The new pinout of the AD8099 reduces the distance between the output and the inverting input of the amplifier. This helps to minimize the parasitic inductance and capacitance of the feedback path, which, in turn, reduces ringing and second harmonic distortion.

### Grounding

When possible, ground and power planes should be used. Ground and power planes reduce the resistance and inductance of the power supply feeds and ground returns. If multiple planes are used, they should be “stitched” together with multiple vias. The returns for the input, output terminations, bypass capacitors, and  $R_G$  should all be kept as close to the AD8099 as possible. Ground vias should be placed at the very end of the component mounting pad to provide a solid ground return. The output load ground and the bypass capacitor grounds should be returned to a common point on the ground plane to minimize parasitic inductance and improve distortion performance. The AD8099 packages feature an exposed paddle. For optimum performance, solder this paddle to ground. For more information on PCB layout and design considerations, refer to section 7-2 of the 2002 Analog Devices Op Amp Applications book.

### Power Supply Bypassing

The AD8099 power supply bypassing has been optimized for each gain configuration as shown in Figure 60 through Figure 66 in the Circuit Configurations section. The values shown should be used when possible. Bypassing is critical for stability, frequency response, distortion, and PSRR performance. The 0.1  $\mu$ F capacitors shown in Figure 60 through Figure 66 should be as close to the supply pins of the AD8099 as possible and the electrolytic capacitors beside them.

### Component Selection

Smaller components less than 1206 SMT case size, offer smaller mounting pads, which have less parasitics and allow for a more compact layout. It is critical for optimum performance that high quality, tight tolerance (where critical), and low drift components be used. For example, tight tolerance and low drift is critical in the selection of the feedback capacitor used in Figure 60. The feedback compensation capacitor in Figure 60 is 1.5pF. This capacitor should be specified with NPO material. NPO material typically has a  $\pm 30$  ppm/ $^{\circ}$ C change over  $-55^{\circ}$ C to  $+125^{\circ}$ C temperature range. For a  $100^{\circ}$ C change, this would result in a 4.5 fF change in capacitance, compared to an X7R material, which would result in a 0.23 pF change, a 15% change from the nominal value. This could introduce excessive peaking, as shown in Figure 68,  $C_F$  vs. Frequency Response.

## DESIGN TOOLS AND TECHNICAL SUPPORT

Analog Devices is committed to the design process by providing technical support and online design tools. ADI offers technical support via free evaluation boards, sample ICs, SPICE models, interactive evaluation tools, application notes, phone and email support—all available at [www.analog.com](http://www.analog.com).

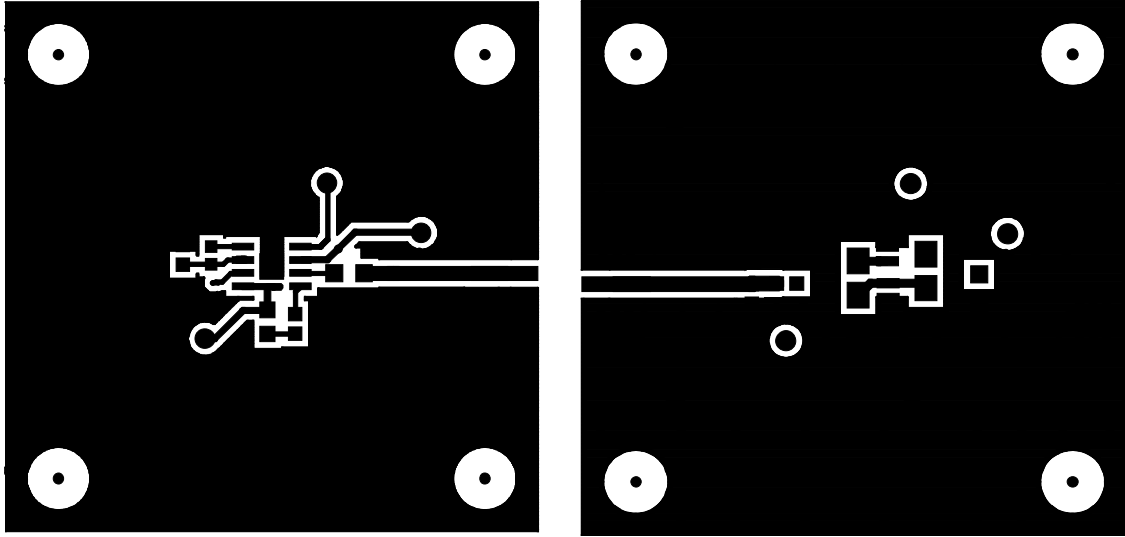

Figure 72. SOIC Evaluation Board Artwork

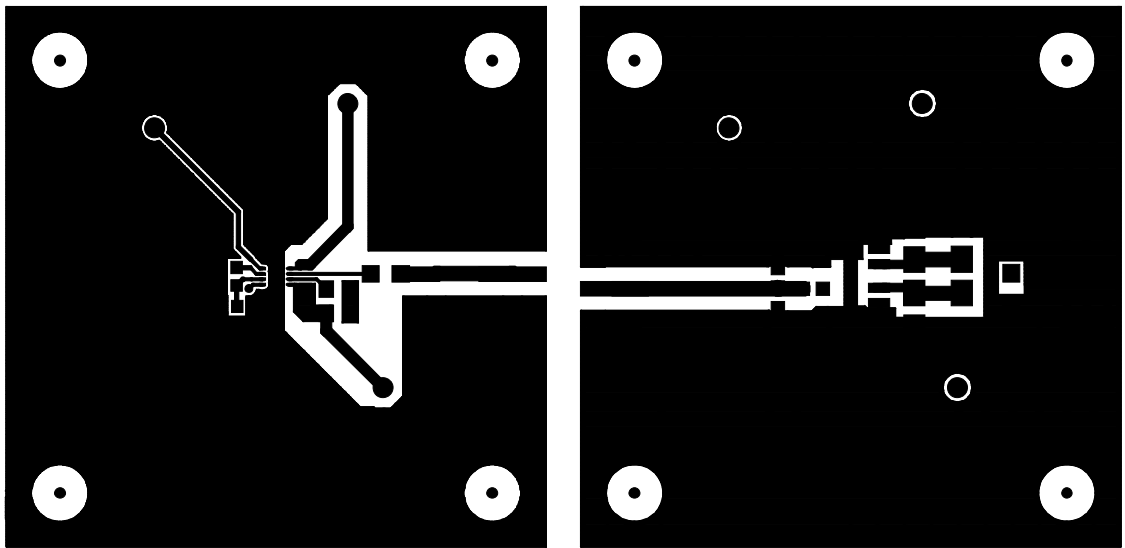

Figure 73. CSP Evaluation Board Artwork

**Evaluation Boards**

There are four different evaluation boards available, as shown in Table 7, and an Application Note, AN-720, that explains the use of the evaluation boards.

**Table 7. Evaluation Board Selection Guide**

Board Configuration	Package Type	
	CSP	SOIC
Inverting	EVAL-ADOPAMP-1CSP-I	EVAL-ADOPAMP-1R-IN
Noninverting	EVAL-ADOPAMP-1CSP-N	EVAL-ADOPAMP-1R-NI



# OUTLINE DIMENSIONS

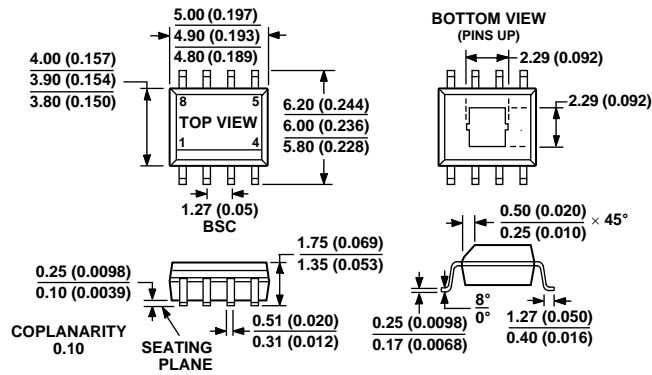

COMPLIANT TO JEDEC STANDARDS MS-012  
 CONTROLLING DIMENSIONS ARE IN MILLIMETERS; INCH DIMENSIONS  
 (IN PARENTHESES) ARE ROUNDED-OFF MILLIMETER EQUIVALENTS FOR  
 REFERENCE ONLY AND ARE NOT APPROPRIATE FOR USE IN DESIGN

Figure 74. 8-Lead Standard Small Outline Package [SOIC-ED]  
 (RD-8-1)

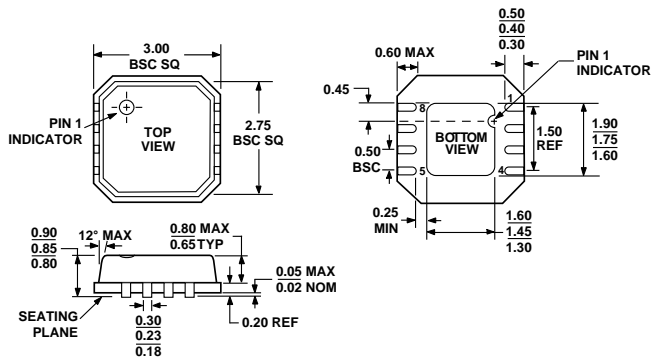

Figure 75. 8-Lead Plastic Surface-Mount Package [CSP]  
 (CP-8)  
 Dimensions shown in millimeters

# AD8099

## ORDERING GUIDE

Model	Minimum Ordering Quantity	Temperature Range	Package Description	Branding	Package Option
AD8099ARD	1	-40°C to +125°C	8-Lead SOIC-ED		RD-8-1
AD8099ARD-REEL	2,500	-40°C to +125°C	8-Lead SOIC-ED		RD-8-1
AD8099ARD-REEL7	1,000	-40°C to +125°C	8-Lead SOIC-ED		RD-8-1
AD8099ARDZ <sup>1</sup>	1	-40°C to +125°C	8-Lead SOIC-ED		RD-8-1
AD8099ARDZ-REEL <sup>1</sup>	2,500	-40°C to +125°C	8-Lead SOIC-ED		RD-8-1
AD8099ARDZ-REEL7 <sup>1</sup>	1,000	-40°C to +125°C	8-Lead SOIC-ED		RD-8-1
AD8099ACP-R2	250	-40°C to +125°C	8-Lead CSP	HDB	CP-8
AD8099ACP-REEL	5,000	-40°C to +125°C	8-Lead CSP	HDB	CP-8
AD8099ACP-REEL7	1,500	-40°C to +125°C	8-Lead CSP	HDB	CP-8
AD8099ACPZ-R2 <sup>1</sup>	250	-40°C to +125°C	8-Lead CSP	HDB	CP-8
AD8099ACPZ-REEL <sup>1</sup>	5,000	-40°C to +125°C	8-Lead CSP	HDB	CP-8
AD8099ACPZ-REEL7 <sup>1</sup>	1,500	-40°C to +125°C	8-Lead CSP	HDB	CP-8

<sup>1</sup> Z = Pb free

**NOTES**

**AD8099**

**NOTES**